



MX60 PV MPPT

(Maximum Power Point Tracking)

Charge Controller

Installation, Programming and User's Manual

Warranty Summary

Dear OutBack Customer,

Thank you for your purchase of OutBack products. We make every effort to assure our power conversion products will give you long and reliable service for your renewable energy system.

As with any manufactured device, repairs might be needed due to damage, inappropriate use, or unintentional defect. Please note the following guidelines regarding warranty service of OutBack products:

- Any and all warranty repairs must conform to the terms of the warranty.
- All OutBack equipment must be installed according to their accompanying instructions and manuals with *specified over-current protection* in order to maintain their warranties.
- The customer must return the component(s) to OutBack securely packaged, properly addressed, and shipping paid. We recommend insuring your package when shipping. Packages that are not securely packaged can sustain additional damage not covered by the warranty or can void warranty repairs.
- There is no allowance or reimbursement for an installer's or user's labor or travel time required to disconnect, service, or reinstall the damaged component(s).
- OutBack will ship the repaired or replacement component(s) prepaid to addresses in the continental United States, where applicable. Shipments outside the U.S. will be sent freight collect.
- In the event of a product malfunction, OutBack cannot bear any responsibility for consequential losses, expenses, or damage to other components.
- *Please read the full warranty at the end of this manual for more information.*



The OutBack Power Systems MX60 PV MPPT Charge Controller is ETL listed to UL1741 (Inverters, Converters, Controllers, and Interconnection System Equipment for Use with Distributed Energy Resources). It is also in compliance with European Union standards EN 61000-6-1 and EN 61000-6-3 (see page 87).

About OutBack Power Systems

OutBack Power Systems is a leader in advanced energy conversion technology. Our products include true sine wave inverter/chargers, a maximum power point charge controller, system communication components, as well as breaker panels, breakers, accessories, and assembled systems.

Notice of Copyright

MX60 PV MPPT (Maximum Power Point Tracking) Charge Controller: Installation, Programming and User's Manual

Copyright © 2007 All rights reserved.

Disclaimer

UNLESS SPECIFICALLY AGREED TO IN WRITING, OUTBACK POWER SYSTEMS:

(a) MAKES NO WARRANTY AS TO THE ACCURACY, SUFFICIENCY OR SUITABILITY OF ANY TECHNICAL OR OTHER INFORMATION PROVIDED IN ITS MANUALS OR OTHER DOCUMENTATION.

(b) ASSUMES NO RESPONSIBILITY OR LIABILITY FOR LOSS OR DAMAGE, WHETHER DIRECT, INDIRECT, CONSEQUENTIAL OR INCIDENTAL, WHICH MIGHT ARISE OUT OF THE USE OF SUCH INFORMATION. THE USE OF ANY SUCH INFORMATION WILL BE ENTIRELY AT THE USER'S RISK.

Date and Revision

April, 2008 REV D Software REV 5.10 and 5.11

Contact Information

OutBack Power Systems

19009 62nd Ave. NE

Arlington, WA 98223

Phone (360) 435-6030

Fax (360) 435-6019

www.outbackpower.com

TABLE OF CONTENTS

INTRODUCTION.....	6
INSTALLATION GUIDELINES AND SAFETY INSTRUCTIONS.....	7
Standards and Requirements.....	8
OPEN CIRCUIT VOLTAGE/WIRE AND DISCONNECT SIZING.....	9
BATTERY SYSTEM VOLTAGE.....	14
POWERING UP.....	15
STATUS SCREEN.....	18
PREPARING FOR RECHARGING.....	19
ACCESSING THE MAIN MENU.....	20
CHARGER SETUP.....	21
AUX MODE.....	22
AUX MODE Path.....	23
AUX Modes Described.....	24
Programming the AUX MODES.....	25
Manual.....	25
Vent Fan.....	25
PV Trigger.....	26
Float.....	27
Error Alarm.....	28
Diversion.....	28
Low Battery Disconnect.....	31
Remote.....	33
BACKLIGHT.....	34
EQ (Equalize).....	34
MISC-MISCELLANEOUS.....	37
WIDE/LMIT Battery Temperature Compensated Limits.....	38
ADVANCED.....	43
Snooze Mode.....	43
Park Mpp.....	44
Mpp Range Limit % Voc.....	44
Sweep Interval.....	45
Vbatt Calibration.....	45
Low Cutoff.....	46
MPPT Mode.....	46

Absorb Time Limits	47
Wakeup Mode.....	48
(DATA) LOGGING	49
Clearing Total and Daily Stats	50
LOG2.....	51
Secondary LOG2 Screen	53
MICRO-HYDRO, WIND TURBINE, AND FUEL CELL APPLICATIONS.....	54
ADVANCED MENU (Micro-Hydro)	56
MX60 ABBREVIATED MENU MAP.....	60
APPLICATION NOTES	61
FACTORY ASSISTANCE	62
SPECIFICATIONS.....	63
UNDERSTANDING THE VARIOUS OPERATIONAL MODES	67
MATE-DISPLAYED MX60 STATUS MODE Screens	71
MATE-DISPLAYED MX60 STATUS METER Screens.....	72
MATE-DISPLAYED MX60 STATUS SETP(SETPOINT) Screens	73
TROUBLESHOOTING GUIDE	74
TYPICAL ARRAY SIZING GUIDE	77
STANDARD vs. AUSTRALIAN DEFAULT SETTINGS.....	78
WIRE DISTANCE CHART.....	79
WIRE AND DISCONNECT SIZING	81
MULTI-STAGE BATTERY CHARGING.....	82
BATTERY TEMPERATURE COMPENSATED VOLTAGE SET POINT	84
SUGGESTED BATTERY CHARGER SET POINTS	85
OWNER'S SYSTEM INFORMATION	86
EU DECLARATION OF CONFORMITY.....	87
WARRANTY INFORMATION	88
PRODUCT REGISTRATION	90

SCOPE

The manual provides safety guidelines and installation information for the MX60 PV MPPT Charge Controller. It does not provide information about specific brands of solar panels and supplies limited information on batteries. Contact the supplier or manufacturer of the solar panels or batteries for further information.

INTRODUCTION

MX60 PV MPPT (Maximum Power Point Tracking) Charge Controller

The OutBack MX60 PV MPPT Charge Controller offers an efficient, safe, multi-stage recharging process that prolongs battery life and assures peak performance from a solar array. This component allows customized battery recharging. The MX60 features include:

- 60 amps maximum continuous output current
- Engineered to work with 12, 24, 36, 48, and 60 VDC battery voltages
- Backlit LCD display screen with 80 characters (4 lines, 20 characters per line)
- Last 64 days of operational data are logged for review
- Voltage step-down capability allowing a higher PV array voltage configuration
- Manual and auto-equalize cycles

The following are the maximum recommended wattage for the most common solar arrays under Standard Test Conditions (1000 watts per square meter of solar panel at 25° C or 77° F):

- 12 VDC battery systems—up to 800 watts of solar panels
- 24 VDC battery systems—up to 1600 watts of solar panels
- 48 VDC battery systems—up to 3200 watts of solar panels

The MX60 also features Maximum Power Point Tracking (MPPT), which seeks out the maximum power available from a solar array and uses it to recharge the batteries. Without this feature, the solar array does not operate at the ideal operating voltage and can only recharge at the level of the battery voltage itself. The MX60 “sweeps” the array’s operating voltage at user-determined sweep intervals to track the Maximum Power Point (MPP) of the PV array.

This manual covers the wiring, installation, and use of the MX60, including explanations of all the Menus displayed on the LCD screen. The MX60 is designed to seamlessly integrate with other OutBack components and can be remotely monitored (up to 1000 feet) by the optional OutBack Power Systems MATE display.

INSTALLATION GUIDELINES AND IMPORTANT SAFETY INSTRUCTIONS

SAVE THESE INSTRUCTIONS

This product is intended to be installed as part of a permanently grounded electrical system as shown in the system configuration sections of this manual with the following important restrictions:

- The negative battery conductor should be bonded to the grounding system at only *one* point in the system. If a GFP (Ground Fault Protector) is present, the battery negative and ground are not bonded.
- With the exception of certain telcom applications, the MX60 should *never* be positive grounded (see page 61, Applications Notes).
- The equipment ground on the MX60 is marked with this symbol: 
- If damaged or malfunctioning, the MX60 should only be disassembled and repaired by a qualified service center. Please contact your renewable energy dealer/installer for assistance. Incorrect reassembly risks malfunction, electric shock or fire.
- *The MX60 is designed for indoor installation or installation inside a weatherproof enclosure. It must not be exposed to rain and should be installed away from direct sunlight.*
- For routine, user-approved maintenance:
 - ▶ Disconnect all circuit breakers and related electrical connections before doing any cleaning or adjustments.
 - ▶ Solar modules may produce hazardous voltages when exposed to light; unless servicing them at night, cover the modules with opaque material before servicing any connected equipment.

Standards and Requirements

All installations must comply with national (NEC) and/or local electrical codes; professional installation is recommended.

DC and Battery-Related Installation Requirements:

- All DC cables must meet NEC standards or applicable local code standards.
- Shut off all DC breakers before connecting any wiring.
- Torque the four-position terminal block and ground terminals to 30 inch pounds/4Nm.
- All wiring must be rated at 75° C or higher.
- Use up to 2 AWG (6.54 mm) to reduce losses and ensure high performance of MX60 (smaller cables can reduce performance and possibly damage the unit).
- Keep cables together (e.g., using a tie-wrap) as much as possible.
- Ensure both cables pass through the *same* knockout and conduit fittings to allow the inductive currents to cancel.
- DC battery over-current protection must be provided as part of the installation. OutBack offers both breakers and fuses for over-current protection.

WARNING - WORKING IN THE VICINITY OF A LEAD ACID BATTERY IS DANGEROUS. BATTERIES GENERATE EXPLOSIVE GASES DURING NORMAL OPERATION.

Design the battery enclosure to prevent accumulation and concentration of hydrogen gas in "pockets" at the top of the enclosure. Vent the battery compartment from the highest point to the outside. A sloped lid can also be used to direct the flow of hydrogen to the vent opening.

CAUTION - To reduce risk of injury, charge only deep-cycle lead acid, lead antimony, lead calcium, gel cell or absorbed glass mat type rechargeable batteries. Other types of batteries may burst, causing personal injury and damage. *Never* charge a frozen battery.

PERSONAL PRECAUTIONS

- Someone should be within range of your voice to come to your aid if needed.
- Keep plenty of fresh water and soap nearby in case battery acid contacts skin, clothing, or eyes.
- Wear complete eye protection. Avoid touching eyes while working near batteries. Wash your hands with soap and warm water when done.
- If battery acid contacts skin or clothing, wash immediately with soap and water. If acid enters an eye, flood the eye with running cool water at once for at least 15 minutes and get medical attention immediately following.
- Baking soda neutralizes lead acid battery electrolyte. Keep a supply on hand in the area of the batteries.
- **NEVER** smoke or allow a spark or flame in vicinity of a battery or generator.
- Be extra cautious to reduce the risk of dropping a metal tool onto batteries. It could short-circuit the batteries or other electrical parts that can result in fire or explosion.
- Remove personal metal items such as rings, bracelets, necklaces, and watches when working with a battery or other electrical current. A battery can produce a short circuit current high enough to weld a ring or the like to metal, causing severe burns.

OPEN CIRCUIT VOLTAGE/WIRE AND DISCONNECT SIZING

Maximum Open Circuit Voltage (Voc)

- Voc is the *unloaded* voltage generated by the solar array.
 - ▶ 141 VDC → MX60 suspends operation to protect components
 - ▶ 150 VDC → max open circuit voltage with the coldest environment (although the MX60 shuts down at 141 VDC, it can absorb up to 150 VDC from the array; anything higher than 150 VDC will damage the MX60)
- As every brand of panel is different, be sure to know the manufacturer's specifications.
- Local temperatures vary seasonally and will affect panel voltage.

Hot weather: lower open circuit voltage/lower maximum power point voltage

- ▶ Cold weather: higher open circuit voltage/higher power point voltage
- ▶ Allow for ambient temperature correction using the following table:

25° to 10° C (77° to 50° F)	multiply by 1.06
9° to 0° C (49° to 32° F)	multiply by 1.10
-1° to -10° C (31° to 14° F)	multiply by 1.13
-11° to -20° C (13° to -4° F)	multiply by 1.17
-21° to -40° C (-5° to -40° F)	multiply by 1.25

- ▶ Check the PV array voltage before connecting it to the MX60.

Wire and Disconnect Sizing

- The output current limit of the MX60 is 60 amps.
- Use a minimum of 6 AWG (4.11 mm) wire for the output between the MX60 and the battery bus bar conductors; a larger size might be required due to temperature and/or conduit fill corrections.
- Install OutBack OBB-60 or OBB-80 amp breakers for disconnect and over current protection.
- The largest PV array that can connect to an MX60 should have a rated short-circuit current of 48 amps STC (Standard Test Conditions).
- Input conductors and circuit breakers must be rated at 1.56 times the short-circuit current of the PV array. OutBack OBB 100% duty continuous breakers only need to be rated at 1.25 times the short-circuit current.
- Please see the wire Distance Chart and complete Wire and Disconnect Sizing on pages 81-83 for other suitable conductor/wire sizing.

Figure 1 Field Wiring Connections and Surge Protection

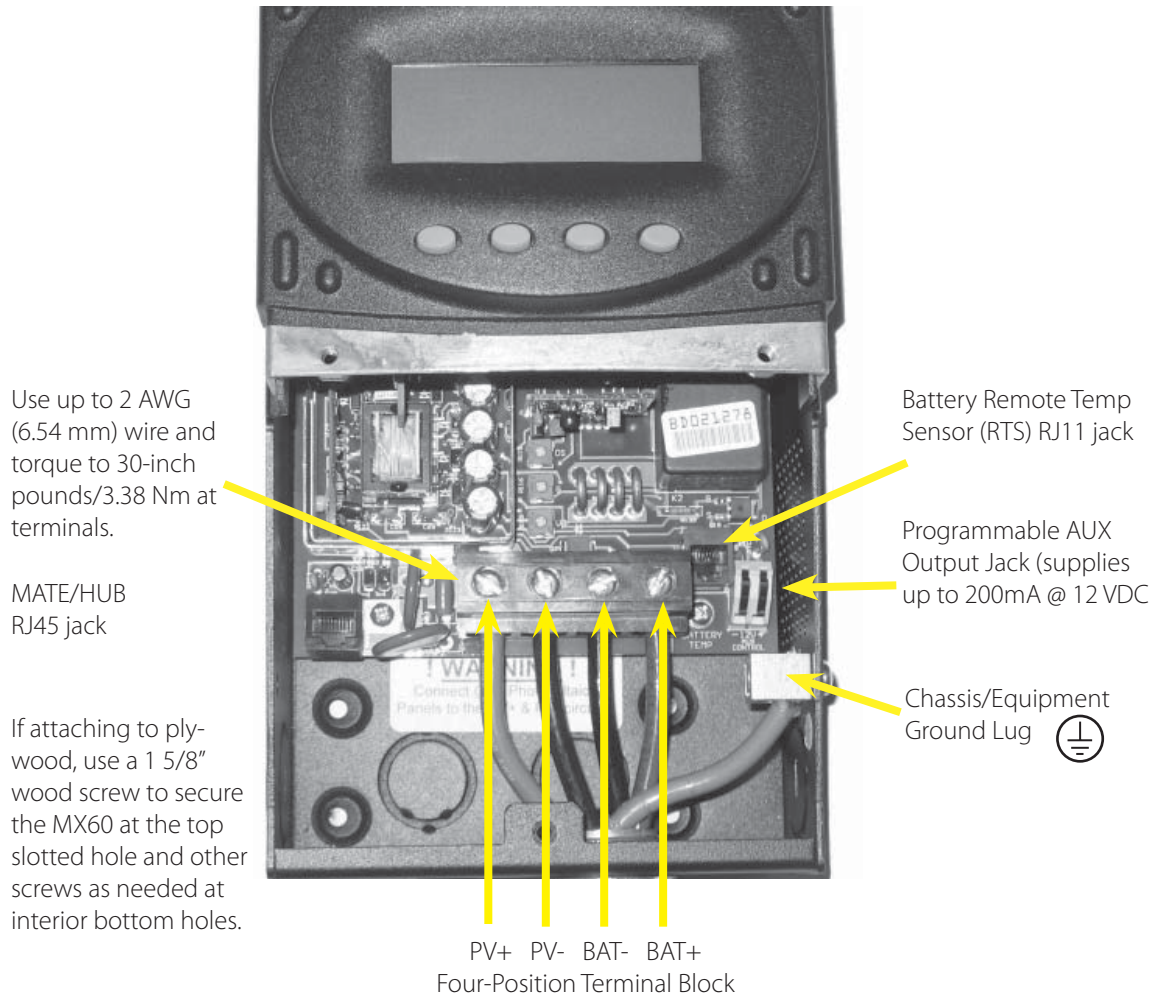

The PV (-) and BAT (-) terminals are connected internally. Only one negative wire may be needed to connect to the Four-Position Terminal Block if the PV - and BAT- conductors are bonded at the negative bus bar. See Figures 2 and 3 for sample wiring diagrams.

NOTE: Each MX 60 requires its own PV array. DO NOT PARALLEL MX 60 PV+ AND PV- TERMINALS TO THE INPUT OF THE MX60. This can cause problems with the MPPT and can cause an MX60 failure.

NOTES

- An optional battery Remote Temperature Sensor (RTS) is recommended for accurate battery recharging (only one RTS is needed for multiple OutBack Series Inverter/Chargers and MX60 units when an OutBack HUB and a MATE are parts of the system). When one RTS is used, it must be connected to the component plugged into the Port 1 of the HUB.
- AUX modes include powering a relay, LED indicator, and Piezo-buzzer or brushless fan.
- The OutBack MATE can display a single MX60 or multiple MX60s if connected to a HUB.
- Surge protection on the input (PV) side of the MX60 and on the battery side is required for extended warranty protection. A dwelling rooftop array requires ground fault protection (OutBack OBB-GFP-80D-125VDC-PNL recommended).
- Always install the MX60 in an upright position. The MX60 must be secured for a safe installation and to retain warranty protection. Use a 1 5/8" wood screw through the slotted hole at the top of the MX60 and at least two screws in the internally located holes at the bottom of the MX60's enclosure.

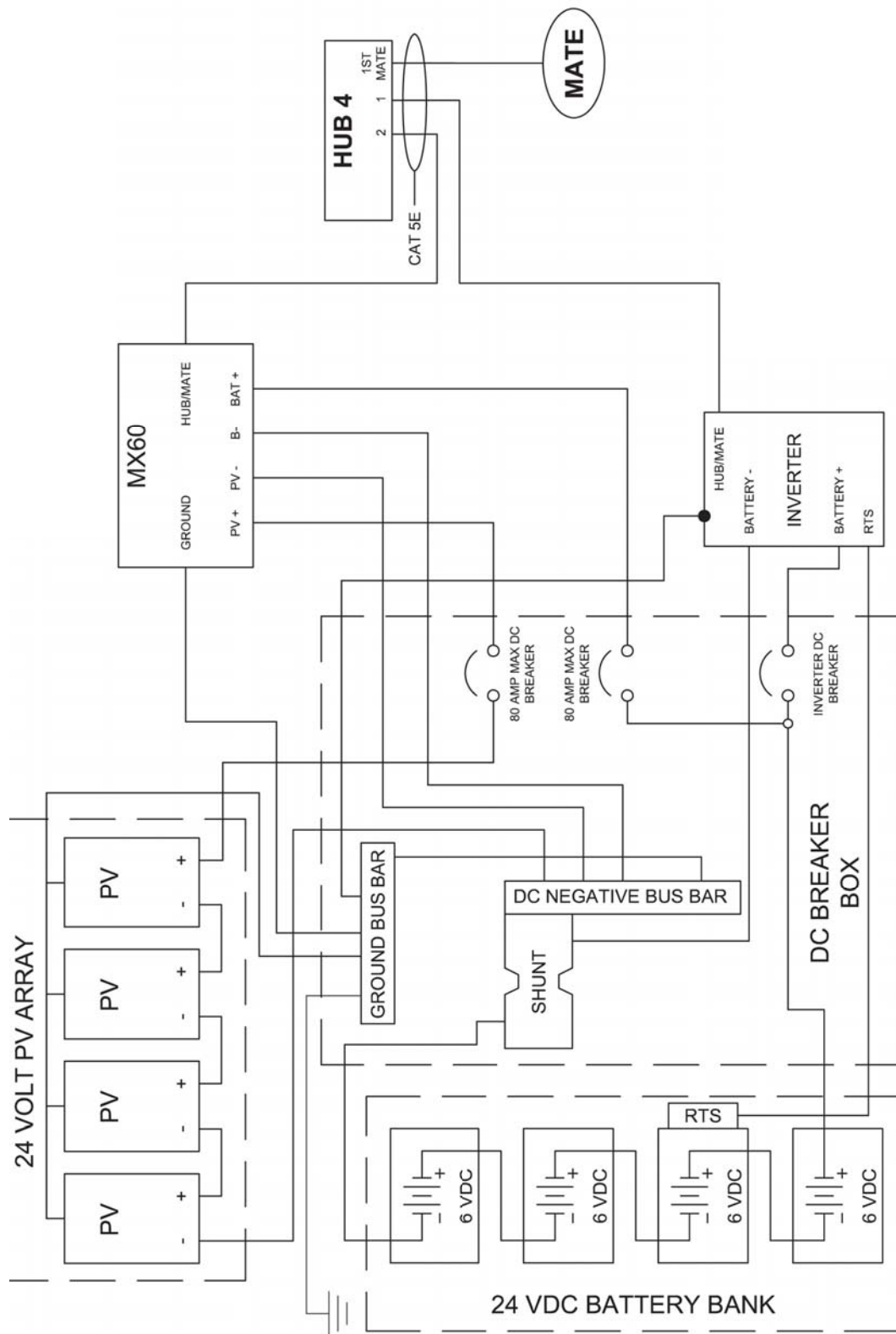

Figure 2 MX60 WIRING DIAGRAM without ground fault protection—the ground conductors tie into the negative.

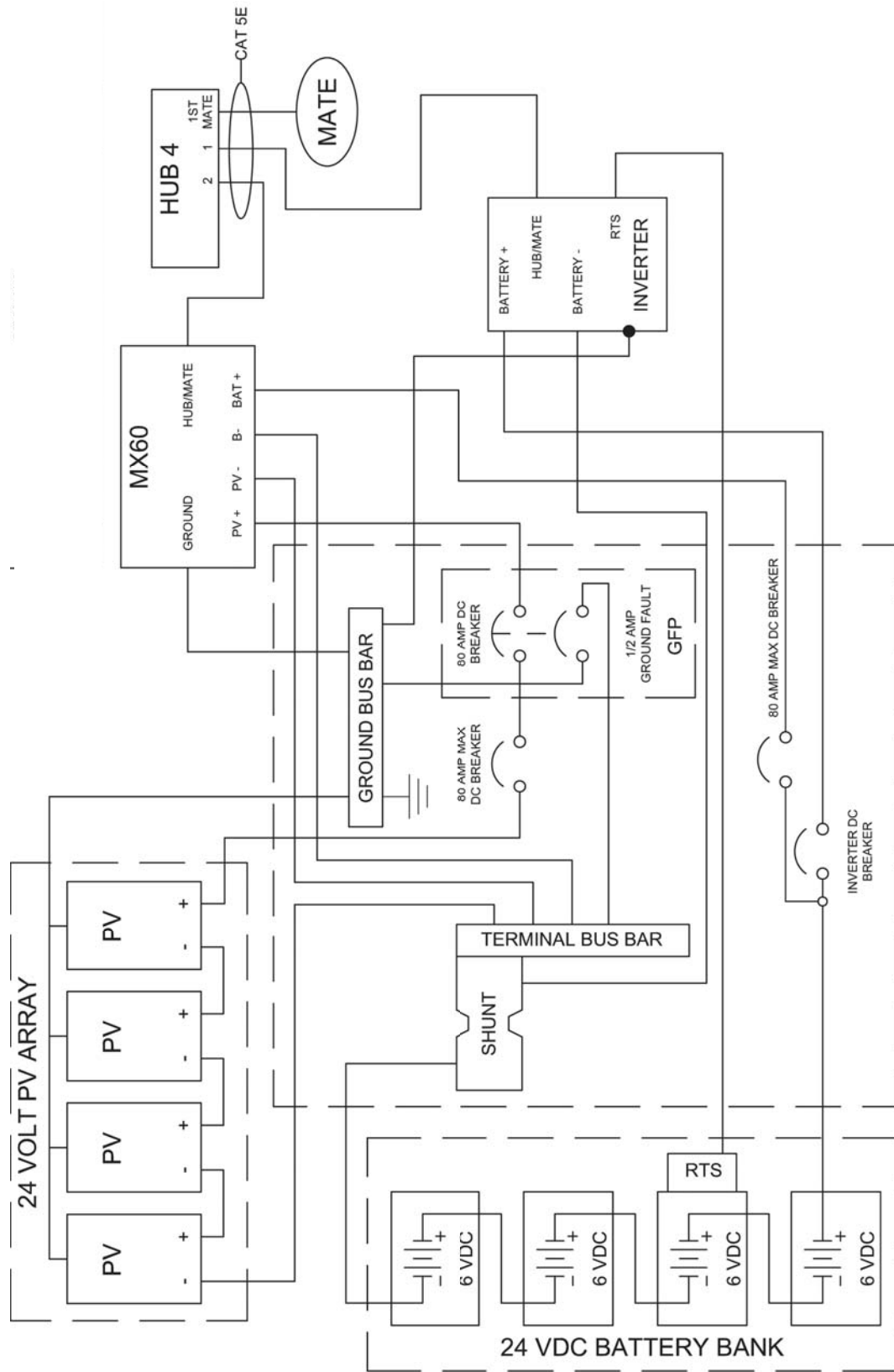



Figure 3 MX60 WIRING DIAGRAM with ground fault protection—the GFP/2 requires a separate ground bus bar.

BATTERY SYSTEM VOLTAGE

- The MX60's default setting is for a 12 VDC battery.
- Change the setting after powering up the MX60 if a different battery voltage is used.
- The PV array voltage—which must not exceed 150 VDC open circuit—is automatically detected.

KEY TO THE EXAMPLE DIAGRAMS

Soft keys: 
 (#1) (#2) (#3) (#4)

Solid black indicates key is to be pressed: 

Down arrow will lead to the next screen: 

Up arrow points to one or more keys that will change a value: 

The keys correspond to any text immediately above them.

POWERING UP

The MX60 power-up sequence first activates the unit and brings up a series of screens; some screens allow the user to change the battery voltage.

NOTE: Be sure the PV input and battery breakers are off before starting the power-up sequence.

OFF SCREEN (*this screen is initially blank at power up*)



With the PV array and battery breakers off, press and hold soft keys #1 and #3 and then turn on the battery breaker (see Figure 4).

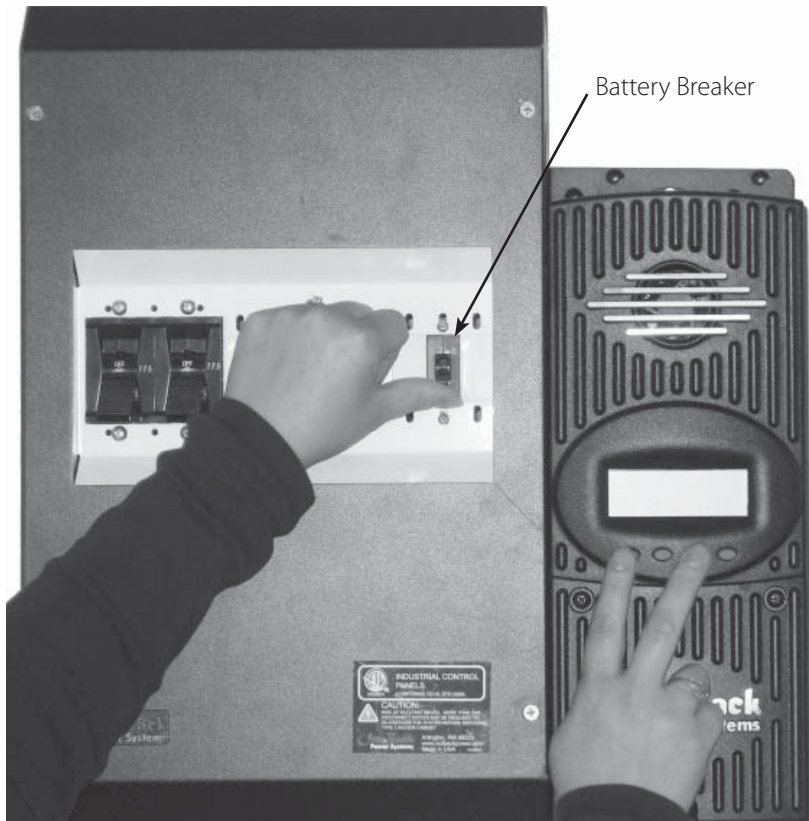
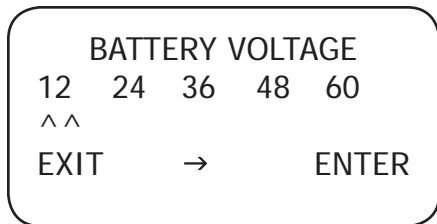
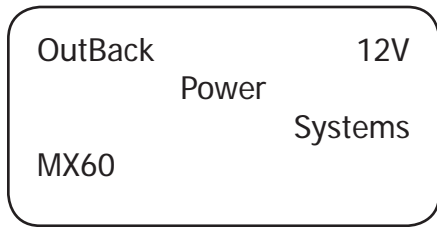

Figure 4

NOTE: The battery voltage must be at least 10.5 V or higher to power up the MX60. If the screen reads "Got Battery?" please see the Troubleshooting Guide on page 74.

Power-Up Screen



Press Either Key

Release both soft keys when the OutBack Power Systems screen appears. The selected battery voltage appears in the upper right hand corner. The *BATTERY VOLTAGE* screen will appear next.

NOTE: The MX60 designation in the lower left corner will read MX60AU for Australian versions and MX60ES for Spanish versions.

"^^" indicates the selected battery voltage. Press the "→" or <ENTER> soft keys to proceed to the *PASSWORD* screen, which prevents unauthorized changes to the system.

Password Screen

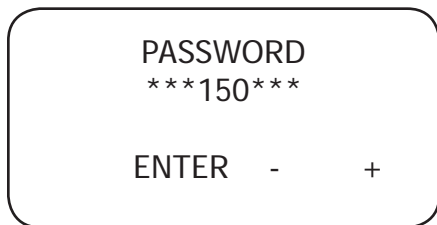

Press the "-" soft key until the password 141 shows on the screen. Press the <ENTER> soft key to return to the *BATTERY VOLTAGE*.

NOTE: 141 is the password for all OutBack products displayed on a screen.

Battery Voltage Screen

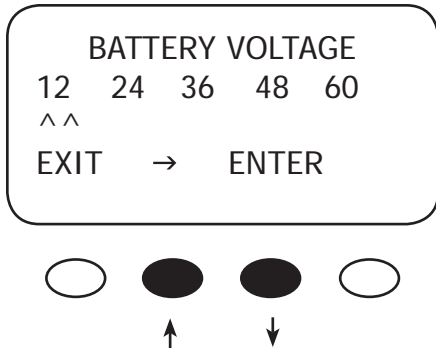

Press the “→” soft key to select a battery voltage. The MX60’s default values are based on a 12 VDC system. Selecting a higher voltage system will change all the default values (e.g., the values will double with a 24 VDC system, triple with a 36 VDC system, etc.). “^^” indicates the chosen voltage. The MX60 will automatically accept the selected battery voltage if left unattended for 5 minutes in this screen. After choosing the voltage, press the <ENTER> soft key to proceed.

Verification Screen

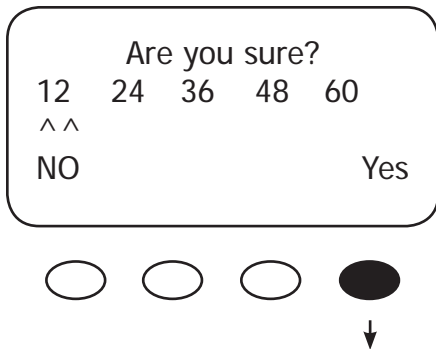

Press the <YES> soft key to proceed if the selected battery voltage is correct. If incorrect, press <NO> to re-enter the correct voltage.

Power-Up Screen

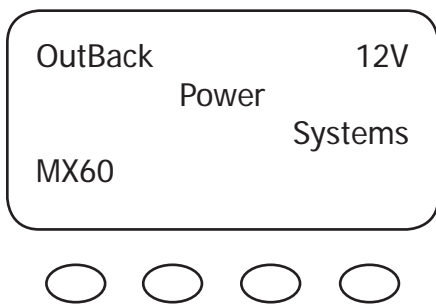

The MX60 briefly returns to the Power-Up screen and then automatically opens the *STATUS* screen which displays information regarding the recharging status. Confirm the battery voltage displayed in the upper right corner is correct.

NOTE: Repeating the Powering Up sequence resets the MX60 Charge Controller to its factory default settings.

STATUS SCREEN

The *STATUS* screen displays system information. See page 67 for detailed information of the different Operational Modes. The optional OutBack MATE displays MX STATUS screens for convenient distant viewing from the installation location of the MX60. Please see page 71 to view the MX screens displayed on the MATE.

The PV voltage will slowly rise to the battery voltage level even when the PV breaker is off – this is normal as the PV capacitor charges up.

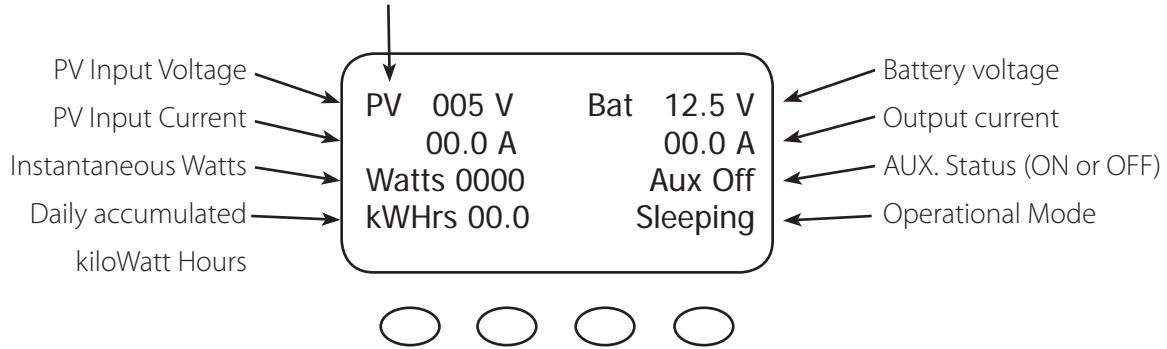

NOTES

- Pressing the first soft key opens the MAIN Menu screen.
- Pressing soft key #2 toggles between Amp Hours and kW Hours displays.

PREPARING FOR RECHARGING

PV 113 V	Bat 12.5 V
00.0 A	00.0 A
Watts 0000	Aux Off
kWHrs 00.0	Sleeping



PV 087 V	Bat 12.5 V
05.0 A	32.9 A
Watts 0412	Aux Off
kWHrs 00.0	B-MPPT



Turn the PV input breaker on. The MX60 automatically detects the PV input voltage.

(NOTE: If PV voltage registers "000V" when the breaker is on, please check the polarity of the PV wires.)

After 5 seconds of stable input voltage, the MX60 enters a "Wakeup" stage, transitions to "Sweeping" and prepares to charge the batteries by tracking the MPP of the solar array.

ACCESSING THE MAIN MENU

The MAIN Menu allows the user to adjust and calibrate the MX60 for maximum performance. From the STATUS screen, press soft key #1 to open the MAIN Menu screen.

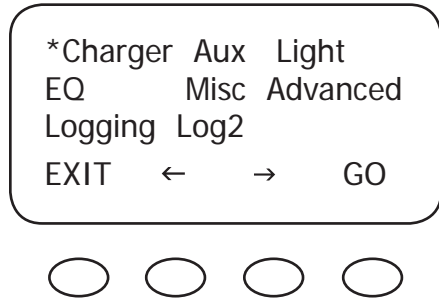

Press ← or → to move the asterisk "*" to the left of the desired screen. The asterisk allows access to any screen to its right.

From the MAIN Menu, a user can choose among the following MX60 functions by aligning the asterisk:

- Charger—CHARGER SETUP
 - ▶ Adjusts the Current Limit, Absorb, and Float recharging voltage set points
- Aux—AUX OUTPUT CONTROL
 - ▶ Secondary control circuit for a vent fan, error alarm, and other system-related additions
- Light—BACKLIGHT CONTROL
 - ▶ Adjusts the backlighting of LCD screen and soft key buttons
- EQ—BATTERY EQUALIZE
 - ▶ Activates battery equalization recharging (manually or automatically)
- Misc—MISCELLANEOUS
 - ▶ Additional settings and service information
- Advanced —ADVANCE MENU
 - ▶ Optimizing/fine-tuning the MX60 (these are advanced Menus that should be left alone until the user has a good working knowledge of the MX60 and its operations)
- Logging—DATA LOGGING
 - ▶ Displays recorded power production information
- Log2—LOG 2
 - ▶ Displays recorded peak system information

Press the <GO> soft key after aligning the asterisk in front of the selected menu choice.

Pressing the <EXIT> soft key in the MAIN Menu returns to the STATUS Menu. Press the <EXIT> soft key in your chosen menu to return to the STATUS screen.

CHARGER SETUP

This screen allows changes to the MX60's recharging voltage set points (Current Limit, Absorb, Float):

- The presently selected numerical value will have an asterisk " * " to the left of it.
- Pressing "→" selects the value to be changed.
- You *may* need to re-enter the password to change these settings.
- The default charger output current limit setting is 60 amps and is adjustable up to 70 amps. At 70 amps, a 70A or 80A breaker must be used between the battery and the MX60.
- Change *ABSORB* and *FLOAT* set points using this screen if the battery manufacturer's recommendations are different than the default values. Otherwise, see page 80 for suggested recharging voltage set points.
- If a battery remote temperature sensor (RTS) is used, its compensated voltage values can be viewed in the *MISCELLANEOUS (Misc)* screen under the Tmp Comp heading.

LIMIT	ABSORB	FLOAT
Amps	Volts	Volts
*60.0	14.4	13.6
EXIT	→ - +	



NOTE: If an RTS is used, set the ABSORB and FLOAT setting voltage based on a 25°C / 77°F setting. These are typically the manufacturer's set points (always consult the battery manufacturer's recommendations). If an RTS is not in use, please see the Non-Battery Temperature Compensated System values (page 86) and adjust the ABSORB/FLOAT values accordingly.

AUX MODE

The AUX is a secondary control circuit—essentially, a small power supply that provides a 12 VDC (up to 200 milliamps) output current. It is either active (12 VDC on) or inactive (12 VDC off).

- To access the *AUX MODE* from the *MAIN* Menu, press the <→> soft key until the asterisk is in front of the AUX selection.
- A 200 milliamps or less, 12 VDC device can be wired directly to the AUX terminal; higher output DC loads require a 12 VDC coil relay—also rated up to 200 milliamps or less for the DC coil—which itself is connected to the AUX output. An internal, re-settable Positive Temperature Coefficient (PTC) fuse protects the AUX internal components.
- For certain AUX control applications the use of a solid state relay is preferred. This is particularly beneficial with applications such as the Diversion mode where fast switching (often called PWM control) allows a more constant battery voltage to be maintained. Both DC and AC load switching solid state relays are widely available from many sources. Eurotherm and Power-IO are two suggested solid state relay manufacturers.
- Most AUX modes or functions are designed for specialized applications and are infrequently used.
- Only one *AUX MODE* can operate at a time (*even if other modes have been preset*).
- Press the <EXIT> soft key to initiate the chosen *AUX MODE*.
- See Figure 5, page 30, for an AUX set-up wiring diagram.

In this Menu, ON and OFF indicators show the present state of the Aux terminals. Pressing the <ON> or <OFF> soft key changes this value.

ON indicates 12 VDC is present at the Aux output terminals. OFF indicates 0 VDC.

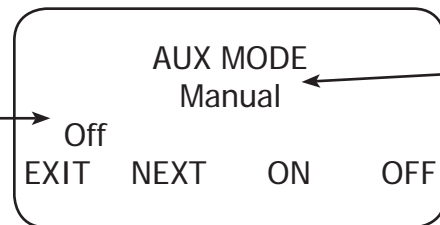

The second line indicates the present mode for the Aux Output.

When the preferred mode is displayed, press the <EXIT> soft key to select it.

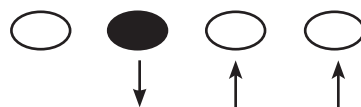

Pressing the <NEXT> soft key changes to the next mode.

Terms

- AUX MODE: what is displayed on the Menu
- Aux Output: 12 VDC is either available or unavailable at the Aux Terminal
- Aux Terminal: the jack to which a relay is wired

AUX modes in order of appearance on the MX60 display:

- *Manual*
- *Vent Fan*
- *PV Trigger*
- *Float*
- *Error Alarm*
- *Diversion*
- *Low Battery Disconnect*
- *Remote*

The most commonly used AUX modes:

- *Vent Fan*
- *Diversion*
- *Low Battery Disconnect*

When an *AUX MODE* is *ON*, 12 VDC is available at the AUX terminals and a condition, such as a voltage set point, is met. Other modes can be programmed in lieu of the specific ones listed here, but the *Vent Fan* mode is most easily changed (e.g., to activate an alarm instead of a fan). Here are the default *AUX* modes:

- **Manual**—pressing either the < **ON** > or < **OFF** > soft key manually activates or deactivates AUX.
- **Vent Fan**—when the *Vent Fan* voltage set point is exceeded, the vent fan will run for at least 15 seconds (the fan helps remove hydrogen from battery enclosure), even if the set point is exceeded for only a few seconds due to a surge. If the set point is exceeded for longer than 15 seconds, the fan will stay on until the voltage drops below the set point. It then takes 15 seconds before the fan shuts off. This is an external fan and not to be confused with the MX60's internal, thermally activated fan which cools the unit.
- **PV Trigger**—activates an alarm or relay (that disconnects the array); when the PV input is too high and exceeds the user-determined voltage set point (should not go over 150 VDC), the *PV Trigger* disconnects after a minimal adjustable amount of *Hold Time*.
- **Float**—powers a load if the MX60 is producing power in the *Float* stage.
- **Error Alarm**—useful for monitoring remote sites, switches to the *Off* state if the MX60 has not charged the batteries for 26 hours or more (not an audible alarm, only displayed as a printed message on MX60 *AUX* Menu).
- **Diversion**—diverts excess power away from batteries when a wind or hydro generator is connected directly to the batteries.
- **Low Batt Disconnect**—activates/deactivates the AUX load(s) when a user-determined voltage and time levels are reached.
- **Remote**—allows OutBack MATE to control the operation of the *AUX MODE* (see MATE manual for details).

Programming the AUX MODES

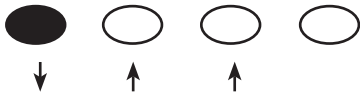
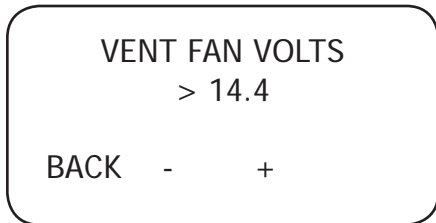
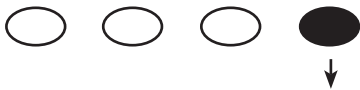
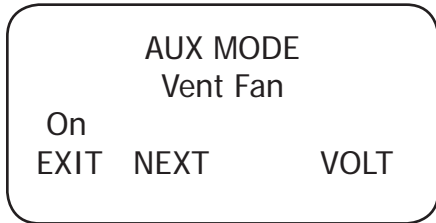
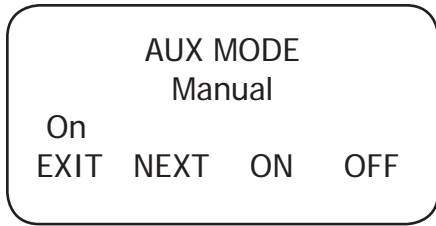

Press the <ON> or <OFF> soft keys to manually activate or deactivate *AUX MODE*. Press the <NEXT> soft key to view the *Vent Fan* screen. To view other screens, continue to press the <NEXT> soft key.

The *Vent Fan* helps remove hydrogen from the battery room. The ventilation fan referred to here is not the same as the MX60 cooling fan. Press the <VOLT> soft key to determine the battery voltage that will activate the *AUX MODE* and start the fan.

Adjust the voltage level using the <-> and <+> soft keys. Press the <BACK> soft key to return to the *Vent Fan* screen.

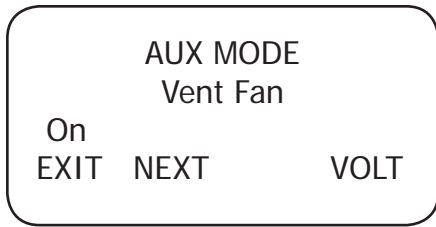

Press the <NEXT> soft key to advance to the *PV Trigger* soft screen.

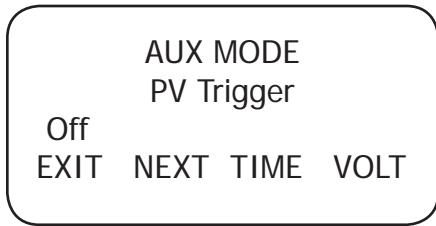

When the PV input is too high and exceeds the user-determined VOLT set point, the *AUX MODE PV Trigger* activates. Press the <VOLT> soft key to adjust the voltage.

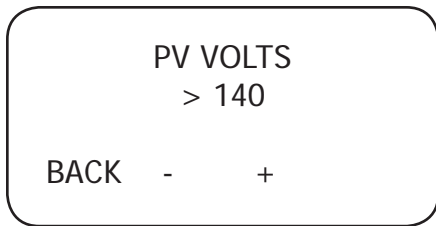

Adjust the voltage within a range of 20V - 150V by pressing the <-> or <+> soft key. Press the <BACK> soft key when finished to return to the *PV Trigger* screen

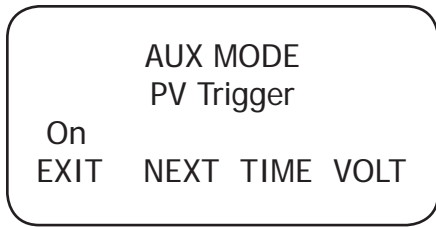

To adjust the minimum amount of time the PV voltage must remain high before deactivating the *AUX MODE*, press the **<TIME>** soft key.

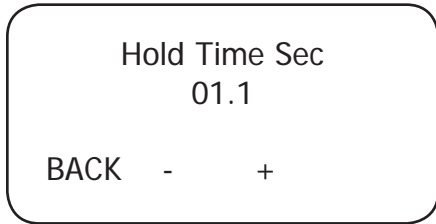

Press the **<->** or the **<+>** soft key to adjust the Hold Time, then press the **<BACK>** soft key to return to the *PV Trigger* screen. In this example, the *AUX MODE* will remain active for 1.1 sec after the PV voltage is below the *PV Trigger* voltage before deactivating the *PV Trigger* and reconnecting to the array.

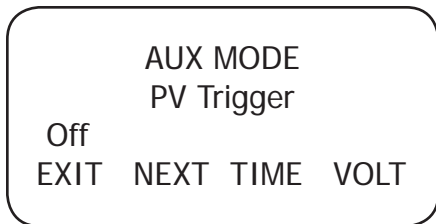

Press the **<NEXT>** soft key to view the *Float* screen.

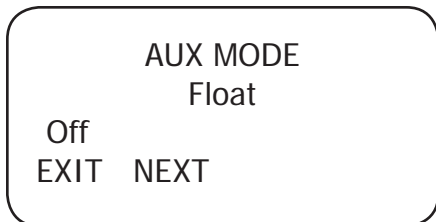

The *AUX MODE* is active when the MX60 is in *Float* and producing power. Press the **<NEXT>** soft key to advance to the *ERROR ALARM* screen.

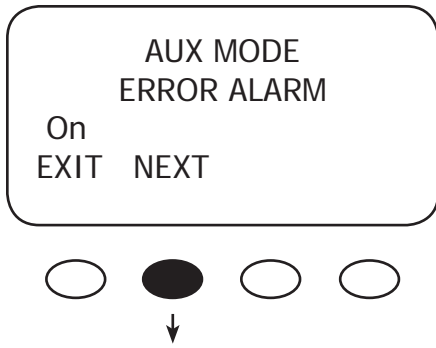

The default state of the *ERROR ALARM* is *On*, meaning 12 VDC is present at the *AUX* terminal. If the MX60 has not charged the batteries for 26 hours or more continuously, the inaudible *ERROR ALARM* goes into an *Off* state. The *ERROR ALARM* is intended for remote locations to signal (e.g., a telecommunication signal to a computer) when the MX60 has not recharged for 26 hrs or more. See *MISCELLANEOUS* screen 3 *Err* for a display of the hourly countdown. Press the <NEXT> soft key to advance to the *Diversion* screen.

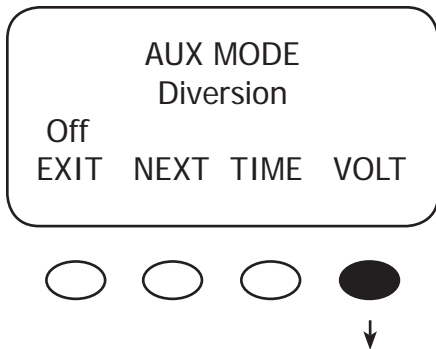

When external DC sources (wind, hydro) are directly connected to a battery bank, any excess power should be sent to a diversion load, such as a heating element. In *Diversion*, the user programs set points—from -5.0 volts to 5.0 volts relative to the *Absorb*, *Float* and *EQ* voltages—to activate the *AUX MODE*.

This is primarily an off-grid function. Pressing the <VOLT> soft key advances to the *Absorb-Float-EQ* screen to adjust the voltage set points.

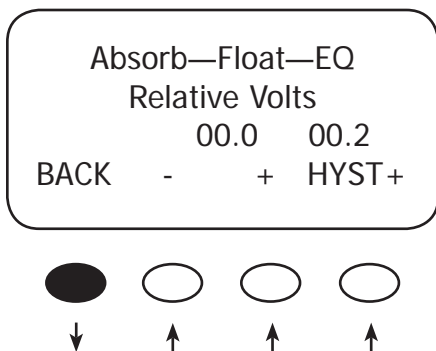

Use this screen to establish the set points for starting and ending the *AUX MODE* relative to the *Absorb*, *Float*, and *EQ* voltages. The <-> and <+> soft keys set the *Diversion* set points. The <HYST> (Hysteresis) set point establishes when the *AUX MODE* becomes inactive after the battery voltage falls below the *Relative Volts* voltage *minus* the *HYST* value. After establishing these values, press the <BACK> soft key to return to the *Diversion* screen (see example on next page).

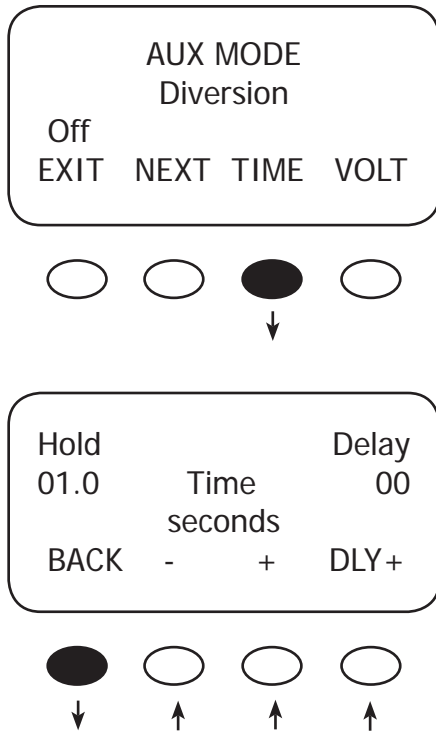

Press the <TIME> soft key to advance to the Time screen which allows the user to adjust the minimum time the AUX MODE is active after the battery voltage falls below the Hysteresis voltage.

Hold Time shows how long the *AUX MODE* stays active after the battery voltage has fallen below the *HYST* (Hysteresis) set point. The user can adjust the *Hold Time* from 0.1 to 25 seconds. If a solid state relay is used, set the Hold time to 0.1 seconds and the Delay time to zero.

The *Delay Time* shows how long the battery voltage must be above the *Relative Volts* before the *AUX MODE* is activated. It can be adjusted from 0 to 24 seconds, *but is rarely required*. Pressing the <BACK> soft key returns to the *AUX MODE DIVERSION* screen.

Example of Diversion

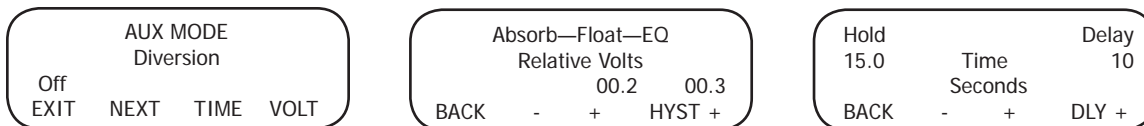

Each recharging state—*Absorb*, *Float*, or *EQ*—has a recharging voltage set point. The *Diversion AUX MODE* can be active (*On*) when the battery voltage is raised above one of these set points for a certain amount of time or inactive (*Off*) when it falls below. The user can determine these voltages and times. In the example above, when the RE source (wind or hydro) raises the battery voltage 00.2v above the chosen set point for a Delay time of 10 seconds—the AUX Output will be active. When the battery voltage falls 00.3V below the HYST voltage set point for a Hold time of 15 sec – the AUX Output will be inactive (*Off*). See Figure 5 for *Diversion Load* and *AUX Wiring Set-Up*.

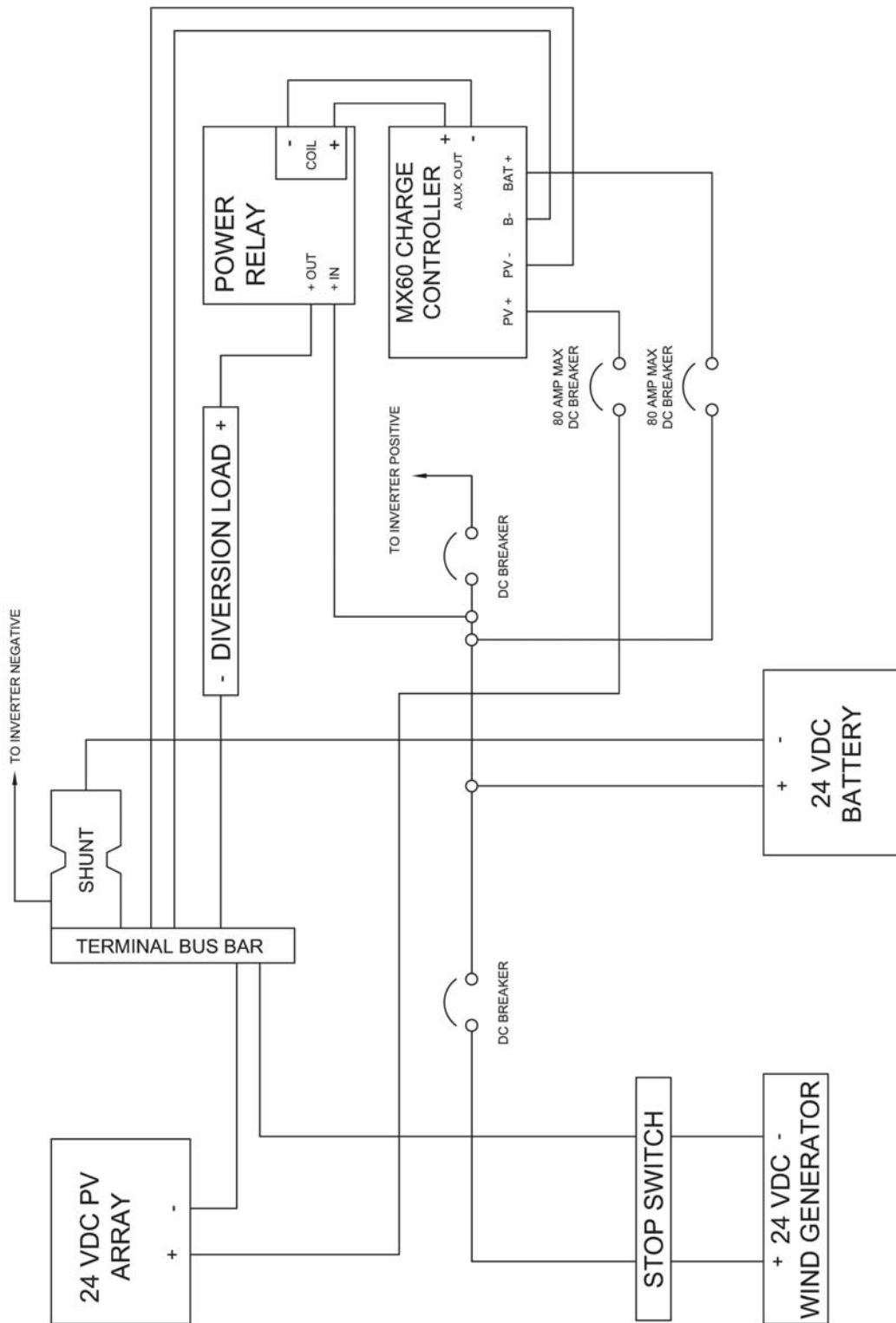
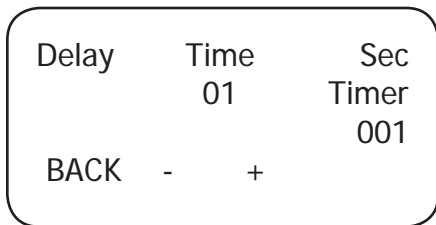
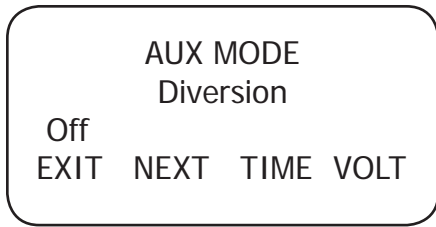

Figure 5 Diversion Load and AUX Wiring Set-Up Illustrated



Press the <NEXT> soft key to view the *Low Batt(ery) Disconnect* screen.

When the battery voltage falls below the disconnect volts, the *AUX connected loads only* are disconnected; the loads are *On* when the battery voltage rises above the reconnect volts. To adjust these set points, press the <TIME> and <VOLT> soft keys.

Press either the <-> or <+> soft key to adjust the delay time. This is the time period the MX60 waits before either activating or deactivating the *AUX MODE* when either the disconnect or reconnect voltages are reached. When the low voltage occurs, the timer shows the seconds remaining before disconnecting. When the reconnect voltage is reached, the timer shows the user-determined time before connecting. Press the <BACK> soft key to return to the *Low Batt Disconnect* screen.

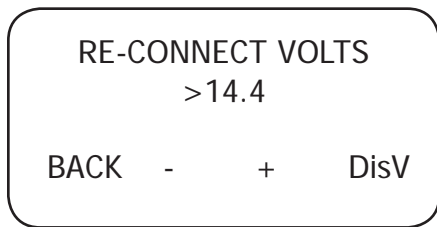
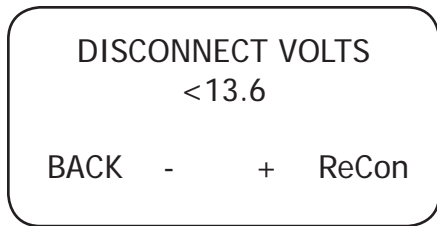

In the *Low Batt Disconnect* screen, press the **<VOLT>** soft key to adjust the battery voltage disconnects set point.

Press either the **<->** or the **<+>** soft key to adjust the disconnect voltage. Press the **<ReCon>** soft key to open the *RE-CONNECT VOLTS* screen.

Press either the **<->** or the **<+>** soft key to adjust the *RE-CONNECT VOLTS* value. The AUX Output activates when the voltage goes above this setting after the timer has counted back to zero. Press the **<BACK>** soft key to return to the *Low Batt Disconnect* screen.

AUX MODE
 Low Batt Disconnect
 On
 EXIT NEXT TIME VOLT



Press the <NEXT> soft key to view the *Remote* screen.

AUX MODE
 Remote
 Off
 EXIT NEXT



In *Remote AUX MODE*, the OutBack MATE can control the MX60's *AUX MODE*. Press the **EXIT** soft key *twice* to return to the *MAIN* Menu screen.

Charger	*Aux	Light
Eq	Misc	Advanced
Logging	Log2	
EXIT	←	→ GO



Press the <→> soft key to move the asterisk to the *Light* option. When the asterisk is in front of *Light*, press the <GO> soft key.

BACKLIGHT



AUTO (default) leaves backlight and soft keys on for 60 seconds whenever any soft key is pressed (pressing any soft key when the LCD is *not* lighted does not change any settings).

ON and *OFF* states are also available.

Press the #1 soft key twice to return to the MAIN Menu screen

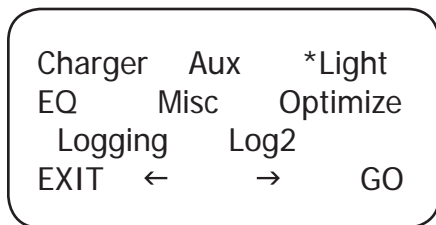

Press the <→> soft key to move the asterisk to the *EQ* option. When the asterisk is to the left of *EQ*, press the <GO> soft key.

EQ—BATTERY EQUALIZE

The intent of an equalization charge is to bring all battery cells to an equal voltage. Sealed batteries should not be equalized unless specifically instructed by the manufacturer. Shut off or minimize all AC and/or DC loads when equalizing and be sure the EQ voltage will not damage any DC load. If possible, ensure the EQ cycle starts and stops the same day it is initiated or unnecessary battery gassing can occur.

- Occasional equalization extends the life of flooded electrolyte batteries.
- Proceed with caution! A vent fan is recommended in enclosed spaces.
- The MX60 allows the user to set voltages and times of equalization process.
- Both manual and auto modes are available.
- EQ is *not* battery temperature compensated.
- *Always check the electrolyte level in the batteries before and after equalizing.*

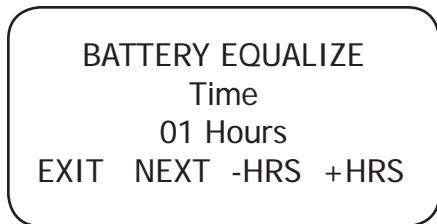
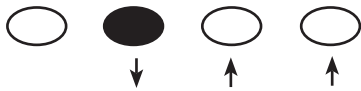
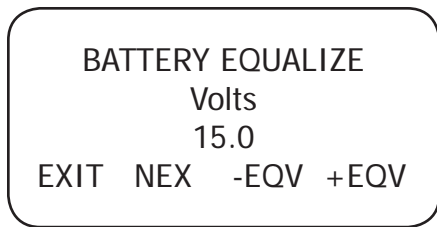

Manual Mode

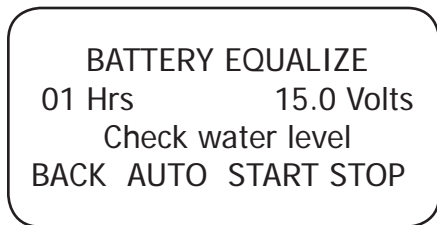

Press either the **<-EQV>** or **<+EQV >** soft key to change the EQ voltage, following your battery manufacturer's recommendations. Note that the factory default EQ voltage is set low, the same as the factory default Absorb voltage. Press the **<NEXT>** soft key to view the *BATTERY EQUALIZE* Time screen.

Press either the **<-HRS>** or **<+HRS>** soft key to set the desired equalization time, up to a seven hour maximum, always following your battery manufacturer's recommendations. Press the **<NEXT>** soft key to view the *BATTERY EQUALIZE* start screen

- Press the **<START>** soft key to manually begin an equalization cycle. To stop the cycle, press the **<STOP>** soft key.
- *EQ-MPPT* display indicates the MX60 is trying to reach the target equalize set point.
- Equalize time **"EQ 0:00"** in Hours:Minutes displays after the equalize set point is reached.
- The incomplete equalization cycle continues into the next day unless the MX60 is powered off or manually stopped. The remaining EQ time can be viewed in the *Log2* Menu.
- EQ cycle terminates when EQ time period is reached.
- After equalizing, an *EQ DONE* message displayed and a *Float* cycle begins.

Press the **<AUTO>** soft key to view the *Auto Equalization* screen.

Auto Mode

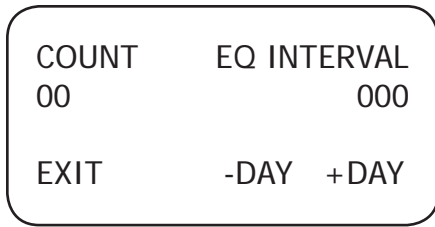

Use the <-DAY> and <+DAY> soft keys to preset the interval day to initiate an automatic equalization cycle. The *EQ INTERVAL* displays the number of days in the interval between cycles and *COUNT* displays how many days of the interval have passed.

- *Auto Mode* initiates when a preset interval day (1-250 days) is reached.
- The default equalize interval (*EQ INTERVAL*) setting is 000 day leaving the Auto EQ disabled.
- "EQ-MPPT" display indicates the MX60 is trying to reach the target equalize set point.
- The equalize time "EQ 0:00" in Hours:Minutes displays after the equalize set point is reached.
- An incomplete equalization cycle continues into the next day unless the MX60 is powered off or manually stopped. The remaining *EQ* time can be viewed in the *Log2* Menu.
- The *COUNT* value will be cleared to 000 when an EQ is started, manually stopped, or MX60 has been powered off.
- After recharging, an *EQ DONE* message displayed and a *Float* cycle begins. To view the *MAIN EQ* screens, press the #1 soft key.

To view the *MAIN EQ* screens, press the #1 soft key.

MISC—MISCELLANEOUS

The *MISCELLANEOUS* screens display extra settings and technical information, some of which is useful for OutBack Power Systems Technical Services.

The *GT* (Grid-tie) value is sent from *GT* series inverter through the *MATE* and *HUB* for Grid-tie control communications. *GT X* means the *MX60* is in grid-tie mode and communicating with the *G Series Inverter*.

Each *MPPT* operation is a state. This number is useful for OutBack troubleshooting.

This is the duty cycle of the converter. At 50%, the *PV terminals* would be twice the battery voltage.

The battery temperature compensated *Absorb (a)* and *Float (f)* set points rise and fall with temperature. If no *RTS* is used, these settings will be the same as those in the charger setting screen.

GT	State	PWM%	ChgT
255	07	50.0	005
Tmp	Comp	a14.4	f13.6
EXIT	NEXT	WIDE	RSTRT

The *Bulk/Absorb* charge timer counts up in *Bulk* and counts down in *Absorb*.



Press **<NEXT>** to Continue to the *Force Bulk/Float* screen.

This soft key covers normal and limited battery compensation voltage range. Press **WIDE** and **LMIT** mode appears, which limits the *Upper* and *Lower* battery-compensated voltage range.

RSTRT forces the *MX60* to restart or wake-up from 5- minute (default) long *Snoozing* mode. Restart and wakeup are mainly service features.

WIDE/LMIT Battery Temperature Compensated Limits

During cold weather, a battery often requires a higher recharging voltage. Lower quality inverters might not accommodate these higher voltages and can shut down during recharging, cutting off power to their loads. The MX60 allows the user to lower the compensated voltage in the *Absorb* cycle so these inverters will remain operating. Also, some batteries have an absolute voltage limit that should not be exceeded and the *WIDE/LMIT* option allows the user to control this during recharging. *WIDE* allows the RTS full control over recharging; *LMIT* sets the ceiling and floor voltages for the RTS.

During hot weather, the *LMIT* feature set point assures recharging will continue at a high enough voltage rather than dropping too low in reaction to a higher ambient temperature. This assures the recharging voltage adequately charges, but should be monitored according to the battery manufacturer's recommendations.

The RTS default compensated voltages apply if the *WIDE/LMIT* option is set to *WIDE* in the *MISC* menu. The upper and lower *LMIT* settings can be viewed in the second menu of the *Log2* screen when *LMIT* is selected.

The *LMIT* set points can be set in the *AUX MODE* menu. To set the *LMIT* upper and lower set points, press the #1 soft key once and return to the *MAIN* Menu. From the *MAIN* Menu, access the *AUX MODE* screens and then the *Low Batt Disconnect* screen.

Path for Setting the *LMIT* Upper and Lower Set Points using AUX:

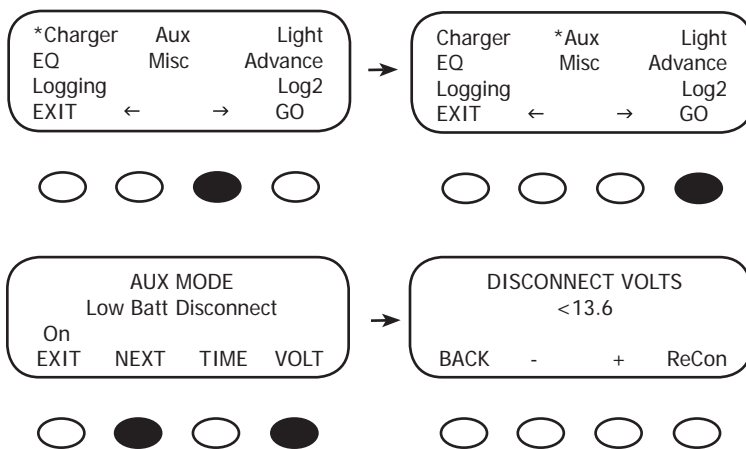

Press <NEXT> until *Low Batt Disconnect* appears, then press <VOLT>

Setting LMIT Upper and Lower Set Points

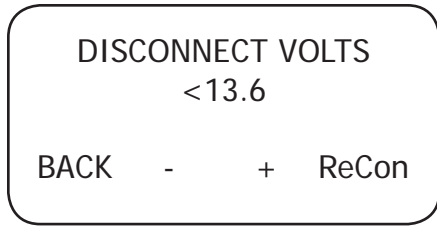

In the *DISCONNECT VOLTS* screen, press the <-> or <+> soft key to adjust the battery voltage range limits. This should be the lowest *Absorb* voltage when the battery temperature is highest. When the desired low voltage is reached, simultaneously press and hold the <-> and <+> soft keys until *Lower Limit* displays on the screen. When *Lower Limit* is displayed, the desired compensated voltage has been stored, and the <-> and <+> soft keys can be released (pressing the <BACK> soft key will return to the previous screen).

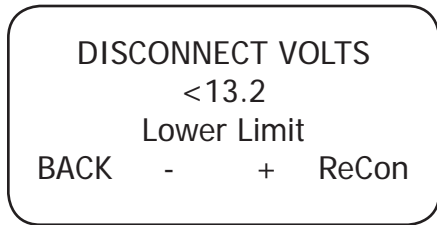

Press the <ReCon> soft key to adjust the upper battery compensated voltage.

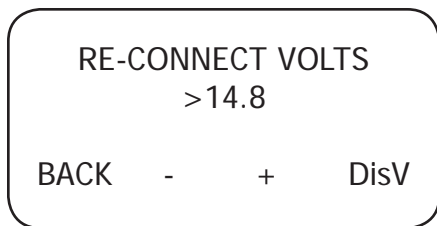

Press the <-> or <+> soft key to adjust the voltage. When finished, simultaneously press and hold the <-> and <+> soft keys until *Upper Limit* is displayed. This should be the highest *Absorb* voltage when the battery temperature is coolest.

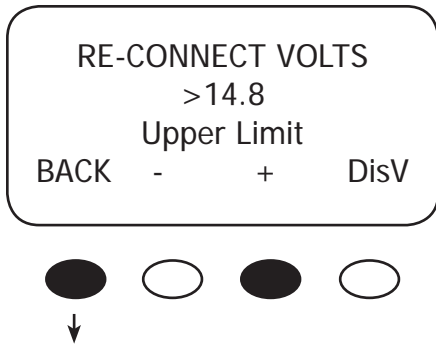

When the *Upper Limit* is displayed, the desired compensated voltage has been stored and the < - > and < + > soft keys can be released.

After setting these limits, *AUX MODE* should be set to *Manual* (default setting) if not used.

NOTE: *WIDE/LMIT* voltages are not applicable in the *Equalize* charging mode.

Pressing the <BACK> soft key returns to the *Low Batt Disconnect* screen.

To confirm the *Upper Limit* and *Lower Limit* voltages

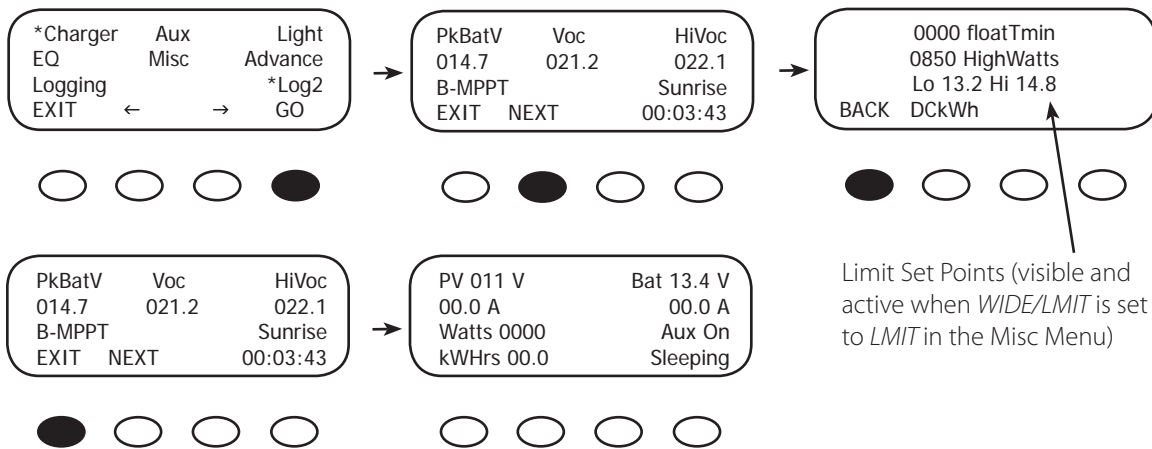

Limit Set Points (visible and active when *WIDE/LMIT* is set to *LIMIT* in the Misc Menu)

After confirming the *Upper Limit* and *Lower Limit* voltages, press the <←> soft key in the *MAIN* Menu. Press the <GO> soft key to advance to the first *MISC* screen. From this screen, you can access *MISCELLANEOUS* Screen 2.

GT	State	PWM%	ChgT
255	07	50.0	005
Tmp	Comp	a14.4	f13.6
EXIT	NEXT	WIDE	RSTRT



FORCE			
EXIT	NEXT	FLOAT	BULK



From the *MISC* screen, press the <NEXT> soft key to view the *FORCE*, *FLOAT*, or *BULK* screen.

Pressing the <FLOAT> or <BULK> soft key forces the MX60 to that specific recharging cycle and returns to the *STATUS* screen. Forcing a *FLOAT* or *BULK* recharge will end an EQ cycle. Press the <NEXT> soft key to view the third *MISCELLANEOUS* screen.

- Force *FLOAT* = float cycle
- Force *BULK* = bulk cycle

MISCELLANEOUS Screen 3

This is the assigned number representing the temperature of the internal components to control the cooling fan. The lower the number, the higher the temperature. 25° C is approximately a value of 525.

In *Float*, if the battery voltage falls below the *ReBulk* voltage set point for at least 90 seconds, the MX60 will automatically reinitiate a *Bulk* charge cycle. The default is set to a very low value (6 volts) and therefore the function will be disabled.

+ReBV increments the *ReBulk Voltage*. It will return to a 6 volt value when a 69 volt value is reached.

The *Err(or)* count increases hourly if the MX60 has not charged the batteries for 26+ hours continuously. The first hour begins at sleeping.

Btmp is a battery temperature sensor reference value used to compensate the charging voltage. This is an arbitrary number between 0 and 255 and is not the actual temperature. An 'X' next to this value indicates a Global external RTS is being used (system with a HUB and MATE).

PCB	Err	Btmp	CFB
398	000	255	0760
ReBulk	06 V	End	00 A
EXIT	+ReBV	-AMP	+AMP

The output value of the internal current sensor is used to calculate output amps, watts, and track the Maximum Power Point of the array.

(*End, -AMP, +AMP*) Normally, an *Absorb* charge cycle is terminated because the battery voltage was regulated at the *Absorb* set point for the maximum time period. Decreasing (*-AMP*) or increasing (*+AMP*) sets an optional end current level. While the battery voltage is at or above the *Absorb* target and the *End* current level is reached at a time delay of 15 seconds, the MX60 will switch to the *Float* charge stage regardless of the charger time minutes. The charger timer (*ChgT*) will be cleared. This is an optional set point and its adjustment is not required in most installations. "00" *Absorb End* amps is the default.

ADVANCED

The *ADVANCED* Menu allows fine-tuning of the MX60 operations including “Snooze” periods and Maximum Power Point limits. In order of appearance, the following modes occur in the *ADVANCED* Menu selections:

- *Snooze Mode* • *Park Mpp (% Voc)* • *MPP Range Limit % Voc* • *Sweep Interva*
- *Vbatt Calibration* • *Low CutOff* • *MPPT Mode* • *Absorb Time Limits* • *Wakeup Mode*

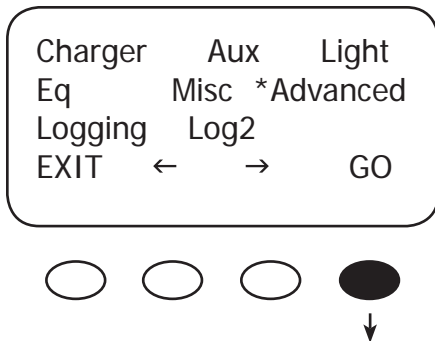

From the *MAIN* Menu, choose *Advanced* and press the <GO> soft key.

The MX60 wakes up when an optimal amount of open circuit voltage (Voc) is available. The Voc varies with external conditions, primarily the weather and time of day, which affect solar panels. If the Voc is insufficient, the MX60 enters *Snoozing* until either a five-minute (default) period passes or there is a 1.5 volt (default) increase in Voc at which point the MX60 reevaluates the Voc for recharging purposes. What is *the* optimal amount? The MX60 tries to recharge when the Voc is greater than the battery voltage by 2 volts, but voltage alone isn't sufficient. An array might have a big increase in voltage first thing in the morning—more than 2 volts difference—but not enough ampacity to recharge.

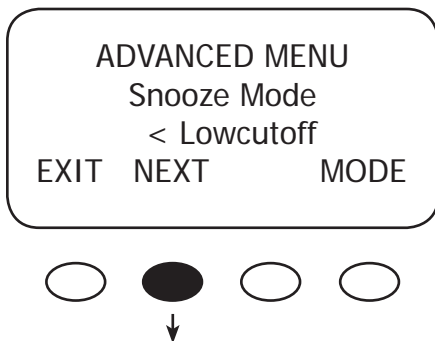

Snoozing also occurs if the recharging current does not reach the user-selected cutoff current set point in the Lowcutoff menu. Press the <MODE> soft key for *Snooze Mode* options. Press the <NEXT> soft key for the *Park Mpp* screen

NOTE: There are four Low Cutoff options:

- <90% Voc—MX60 snoozes if Voc does not rise to greater than 90% of last measured Voc during a full sweep
- <50% Voc—snoozes if Voc does not rise to greater than 50% of last measured Voc during a full sweep
- <Lowcutoff—default snooze mode, snoozes if initial sweep does not reach Low Cutoff Amps during a full sweep
- *Disabled*—no snoozing, MX60 will cycle on and off many times (*not recommended due to ongoing relay-clicking*)

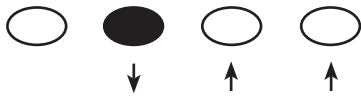
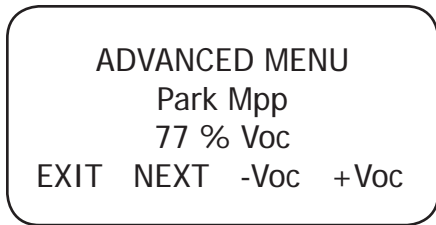

Auto Sweep MPPT Mode (see page 46) seeks the solar array's maximum available voltage to recharge the batteries. The MX60 is best left in this default mode for most recharging purposes. If the output current is *below* five amps (e.g., overcast day or early mornings and late evenings), the MX60 will operate at the percentage of the Voc shown on the *Park Mpp* (Maximum Power Point) screen. The 77% VOC default is close to the MPP for most arrays. A higher value may be necessary for different applications such as a 12 VDC array to a 12 VDC battery. To change the percentage of VOC press either the <-VOC> or <+VOC> soft key. Press the <NEXT> soft key to view the next *ADVANCED* Menu screen.

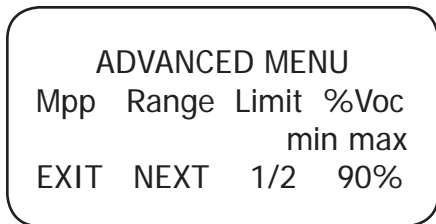

Use 1/2 value for high input arrays to speed up initial sweep.

The *Mpp Range Limit % Voc* adjusts the upper *Mpp* limit of the VOC. The default MX60 MPP voltage limit is set at 90% of the VOC and is normally left alone for an array. If an MX60 sweep finds an MPP voltage *outside* of this range, it will revert to the *Park Mpp* value. Setting to 1/2 reduces the initial sweep time on a high input voltage array.

The MPP adjustable MX60 limits are 80%, 85%, 90%, and 99% of the VOC. The *min* range limit setting may be set to *FUL* if something other than a PV array is connected to the input of the MX60, such as a Micro-Hydro generator (see page 54), but the Voc cannot exceed 150 VDC at any time. Press the <min> or <max> soft key to adjust the MPP range limit. When done, press the <NEXT> soft key to view the *Sweep Interval* screen.

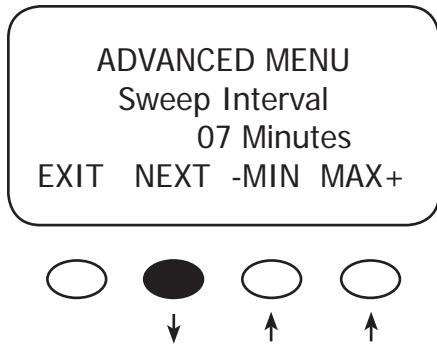

The *Sweep Interval* mode or mini-sweep determines how often a sweep occurs, ranging from 0-15 minutes. A sweep is a search for the best MPP for the array. At zero minutes, the MPPT mini-sweep function is disabled (this is not recommended for PV arrays). No sweeping occurs if the output current is under five amps because it operates at the *Park Mpp* value. Sweeping does occur when the output current is higher than five amps or to maintain user current limit and to track the MPP of the array throughout the day. A mini-sweep is an accurate but less extensive version of the full initial sweep done at wakeup.

Press the **<-MIN>** soft key to decrease minisweep interval minutes or press the **<+MIN>** soft key to increase the minutes. Press the **<NEXT>** soft key to view the *Vbatt Calibration* screen.

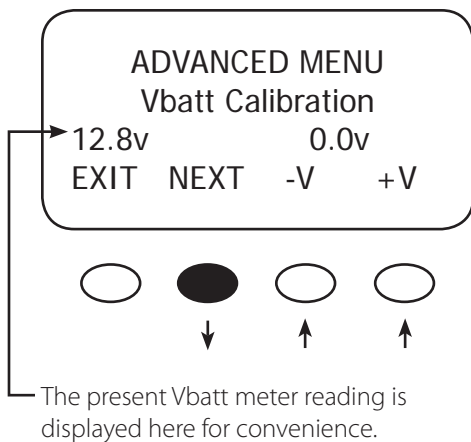

A quality calibrated voltmeter will provide even more accurate MX60 battery voltage readings if an undesirable voltage drop is present. When measuring battery voltage, ensure a good connection is made to the Four-Position Terminal Block. Check the battery temperature compensation voltages if voltages are much different than you expect from the charger setup *Absorb* and *Float* voltage settings. Use the **<-V>** and **<+V>** soft keys to match the readings from the voltmeter. When finished, press the **<NEXT>** soft key to view the next screen.

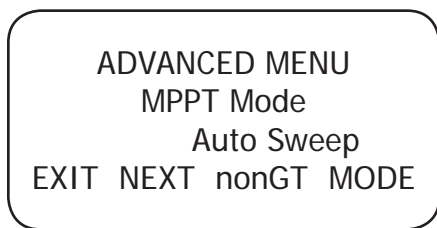
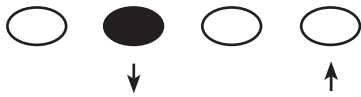
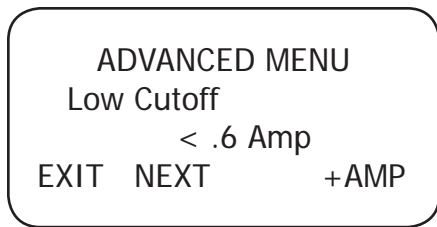

The default value is nonGT or non-grid-tied. Select GT mode if you have a GVFX or GTFX inverter, MATE and HUB connected to the MX60. Selecting GT establishes the proper grid-tie mode communications between the G-series FX and the MX60.

Low Cutoff sets the battery charger's lowest allowable current limit the MX60 will charge in MPPT mode before stopping and returning to *Snoozing*. The *Low Cutoff* is adjustable from .2 amps to 1 amp; .6 amps is the default *Low Cutoff* current. Raising this value will assist the MX60 in entering *Sleeping* mode at night. Press the **<+Amp>** soft key to raise this limit. When finished, press the **<NEXT>** soft key to view the *MPPT Mode* screen.

This screen allows the user to choose one of these modes:

- *Auto Sweep MPPT Mode* (the default and preferred mode), which sweeps the PV upon wakeup and then does mini *Sweeps* from that point on at the selected Sweep Interval. If the sweep interval is set at 0 minutes, the MX60 awakes every 1.5 hours and does a full sweep. *Auto Restart* applies here as well (see *LOG2 Auto Restart*, page 52).
- *U-Pick % (Voc) MPPT mode* operates the PV voltage at a user-selected percentage of the Voc which is displayed in the *Park Mpp % Voc* screen. *U_Pick %* acquires a new Voc value every *Sweep* Interval. If the mini-sweep interval is set to 0 minutes, a new Voc may be acquired once every 1.5 hrs. depending on the *Auto Restart* setting (see *LOG2 Auto Restart*, page 52). This is an alternative to the *Auto Sweep* mode and may also be useful for micro-hydro applications.

Press the **<MODE>** soft key to choose an MPPT mode and the **<nonGT>** soft key if you have an OutBack GT series inverter system with a HUB and MATE. Press the **<NEXT>** soft key to view the *Absorb Time Limits* screen

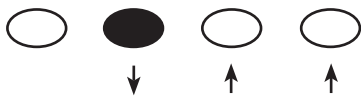
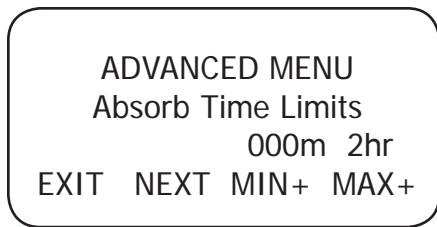

In the *Absorb Time Limits* screen, the user can set the minimum and maximum times the MX60 stays in the *Absorb* recharge cycle.

- *MAXimum* is adjustable from 0 to 4 hours.
- *MINimum* is adjustable from 0 minutes (the default) up to the *MAX Absorb Time Limit* minus 10 minutes. (EX: *MAX Absorb Time* = 2 hours or 120 minutes; *MIN Absorb Time* adjusted up to 110 minutes)

To adjust the limits, press either the <MIN+> or <MAX+> soft key. When finished, press the <NEXT> soft key to view the next screen.

- A *Bulk* cycle starts each morning. The charge timer (*ChgT*) is preset to the minimum *Absorb* time limit (zero minutes) while the *Bulk/Absorb Charge Timer* counts up in minutes.
- The timer stops when it reaches the *Maximum Absorb Time* or the *Absorb* voltage set point is met.
- The *ChgT* counts down to zero after the *Absorb* voltage is reached.
- At zero, the MX60 goes into *Float* stage and may briefly display “Bat Full” (Battery Full) then “Float.”
- When the battery voltage drops below the float voltage set point, the MX60 recharges to maintain this set point, employing the *F(Float)-MPPT* function.
- If the system cannot maintain the *Absorb* voltage set point during the *Absorb* cycle, the timer will stop counting down and begin counting up towards the *MAX Absorb* time as the MX60 transitions to *Bulk* (*BMPPT*). This up and down counting *will continue until the charge timer counts down to zero*. The *Absorb* cycle can be disabled by setting the maximum to 0hr.

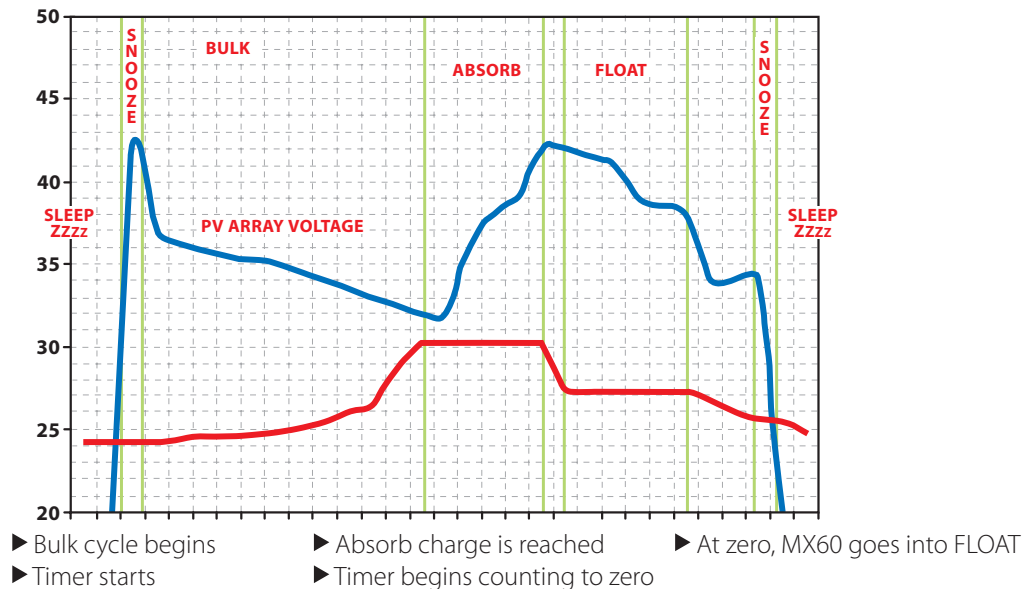

NOTE: In BULK, the MX60 will charge as long as necessary to complete the cycle, regardless of the timer's set points.

```

ADVANCED MENU
Wakeup Mode
01.5v 05m
EXIT NEXT +VOC +Min

```



Wakeup Mode selects how often the MX60 does a *Wakeup* during “Snoozing” periods. Since environmental condition impact the open circuit voltage (Voc) of an array, a user selectable Voc rise in value will allow the controller to *Wakeup* sooner or later based on the last measured Voc value. A selectable delay time in minutes will also allow the controller to *Wakeup* sooner or later if the measured Voc did not meet the user selectable Voc rise in value. Before changing these values, monitor your system for a week or so using the factory defaults and then gradually adjust the set points. If they’re set too high, the MX60 might not wake up soon or often enough, which means a loss of power production. Note: +VOC ranges from 1.5V up to 9.5V. +MIN ranges from 5 up to 15 minutes. Press the <EXIT> soft key to return to the *MAIN* Menu.

```

Charger Aux Light
Eq Misc *Advanced
Logging Log2
EXIT ← → GO

```



From the *MAIN* Menu, press the <→> soft key to move the asterisk next to the *Logging* function and then press the <GO> soft key.

(DATA) LOGGING

The MX60 records battery float and daily kilowatt-hour (kWh) information for the previous 64 days. This data can be compared, for instance, with weather reports to confirm the MX60's performance. When 64 days are reached, for every new day of data recorded, a day is eliminated from the front end of the count in the order they were recorded.

Total power production may be viewed as amp hours or kilowatt-hours depending on display setting in the STATUS screen. The *TotalKWh* or *TotalKAh* accumulates the daily values and continue beyond 64 days of data.

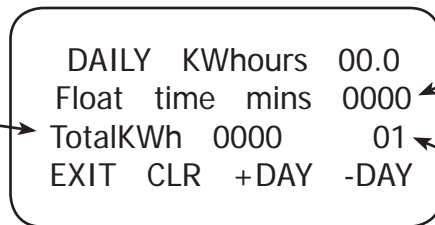

The minutes the MX60 spent floating the batteries for each of the last 64 days. The present day's *Float* time can be found in the *Log2* screens.

Day 01 is yesterday and *Day 02* is two days ago, etc.

Pressing <CLR> takes you to the *CLEAR*, *DALY* (*DAILY*), and *TOTL* (*TOTAL*) Menu and **EXIT** takes you back to the main *STATUS* screen.

Press - **DAY**: goes back one day Press +**DAY**: goes forward one day

If starting on Day 01 and <+DAY> is pressed, the value from 64 days ago is presented.

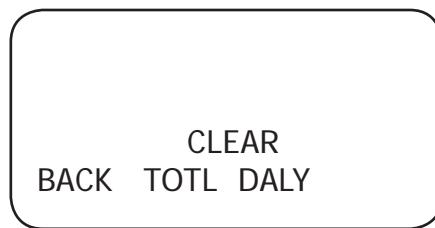

Pressing and holding the <TOTL> or <DALY> (*TOTAL AND DAILY*) soft key will prompt you to erase those total accumulated values. Pressing **BACK** returns to the *Logging* screen.

Clearing Totals and Daily Stats

- Pressing and holding <TOTL> for three seconds brings up the *Are you sure?* screen, prompting you to clear the total accumulated kWh and kAh statistical values in the MX60.
- Pressing and holding <DALY> for three seconds will bring up the *Are you sure?* screen for clearing all of the 64 Daily logged values. After *Yes* is confirmed, the values will be cleared. It may take a few seconds for all 64 daily values to be cleared before the confirmation screen goes away.
- Pressing <BACK> brings back the Logging screen.

NOTE: If two or more MX60s are used in the same system and are started up or cleared on different days, their numeric dates will not be the same. This can lead to some misunderstandings when looking back and comparing data between the two or more units. A user looking back at day 12 on *both* units would find very different results.

To return to the *MAIN* Menu, press the #1 soft key from any screen.

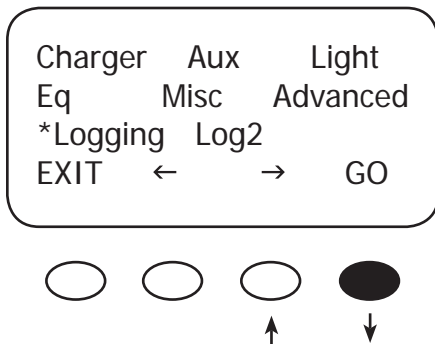

From the *MAIN* Menu, press the <→> soft key to move the asterisk next to the *Log2* function and then press the <GO> soft key.

LOG2

The *Log2* screen displays additional voltage and time information.

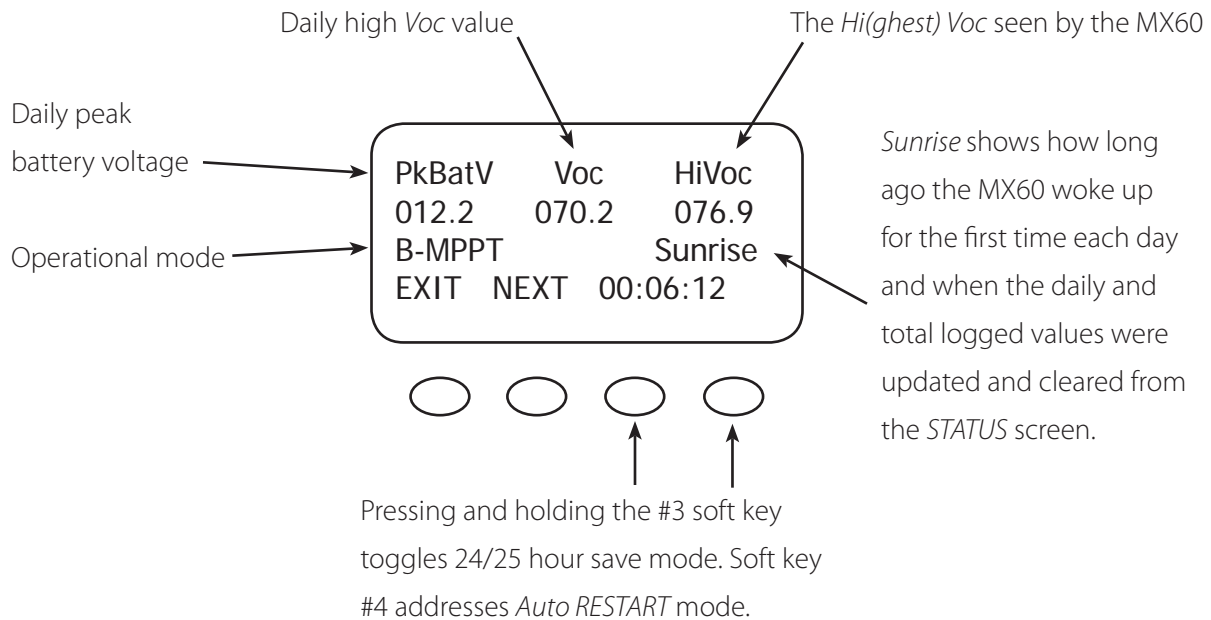

PkBatV logs the peak battery voltage and operational mode simultaneously, updating daily at first wakeup; it can also be reset to the present battery voltage by powering off the controller. This helps determine any degree of voltage overshooting. The peak battery voltage should not be used to identify that the controller has charged the battery to a higher voltage than its regulation set point.

NOTE: If controller power is disconnected, the *BatTmpErr* becomes the default operational mode until the controller wakes up.

Auto Restart

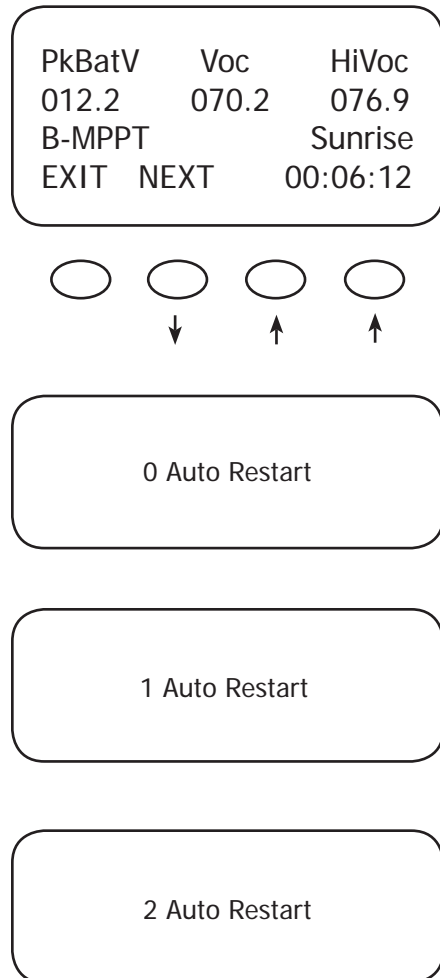

Pressing and holding the #4 soft key for several seconds selects among the three MX60 *Auto ReStart* modes: 0, 1, and 2 (default). *Auto ReStart* allows the MX60 to perform internal recalibrations and eliminate any possibility of software errors. To change the mode, release the #4 soft key and press and hold again.

- *Mode 0*— *Auto ReStart* mode is disabled; the MX60 recharges continuously from an available source and never *Restarts*. *Mode 0* would be chosen to avoid spinning a microhydro generator every 1.5 hours.
- *Mode 1*—once every 1.5 hours, when the MX60 is in *Bulk*, it will briefly *Restart* and initiate a full panel sweep. This will not reset any counters or charging stages or statistics.
- *Mode 2*— *Auto ReStart* every 1.5 hours; in *Bulk*, *Absorb*, and *Float* modes, it will briefly *Restart* and initiate a full panel sweep. This will not reset any counters or charging stages or statistics.

The MX60's sunrise-related activity can be influenced. During certain days of the year, the sun never "sets" in parts of Alaska, for instance, and the PV output is constant. The MX60 responds to these situations by generating its own sunrise reading at either 24 or 25 hours with 25 hours being the default value. *After this 24 or 25 hour period, the MX60 automatically initiates a BULK cycle and logs the daily KiloWattHour / AmpHour statistics and Float Time to be logged and accumulated in the Logging screen.* Pressing down and holding the third soft key, then releasing and pressing and holding again for a few seconds, will toggle the value between 24 and 25 hours. Mini-sweeps at the selected sweep interval will initiate on time in either of these modes. Press the <NEXT> soft key to view the secondary *Log2* screen.

After 3 hours of sleeping, the MX60 displays *Zzzz...* This means that the next wakeup will cause the daily KiloWattHour / AmpHour statistics and *Float Time* to be logged and accumulated in the *Logging* screen. *This (the next wakeup) will also initiate a Bulk charge cycle.*

Secondary LOG2 Screen

The *Secondary Log2* screen shows the basic recharging state of the MX60 (EQ, FLOAT) time in minutes, and the daily maximum (HighWatts) wattage seen by the MX60 during the day.

When initiated, *EQ* information will be displayed here.

The lower and upper battery temperature compensation voltage is visible and active only when the mode is set to *LMIT* (5.11 Rev).

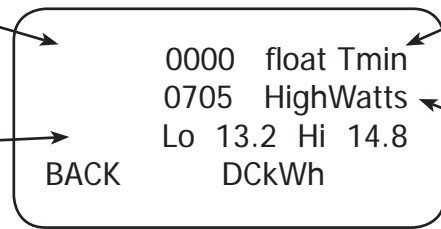

The present day's time—in minutes—spent in *Float* stage.

This value is the peak daily Watts seen by the MX60.



Press soft key #3 to display the accumulated total kWh reading in AC or DC the *Data Logging* screen.

- *DCKWh* (default) shows DC kiloWatthours and should be used in a non-grid-tied system.
- *ACKWh* is used with a grid-tied system. The heading in the logging screen will change to *TotalKWh AC*.
- *TotalKWh AC* is based on a 90% inverter efficiency (1kWh DC = 0.9kWh AC).

NOTE: Float time does not accumulate (1) when the MX60 is sleeping or (2) when an external power source keeps the battery above float voltage.

MICRO-HYDRO, WIND TURBINE, AND FUEL CELL APPLICATIONS

The MX60 is designed to work with solar arrays. Although it will work with micro-hydro and fuel cell, OutBack Power Systems can only offer limited technical support for these applications because there is too much variance in micro-hydro and fuel cell generator specifications. When used for micro-hydro or fuel cell applications, the MX60 warranty will be honored only if the manufacturer and turbine model have been approved by OutBack Power Systems. Please check with one of the following manufacturers or OutBack Power Systems before employing the MX60:

- Harris Hydroelectric
(831) 425-7652
www.harrishydro.com
- Alternative Power & Machine
(541) 476-8916
www.apmhydro.com
- Energy Systems & Design
(506) 433-3151
www.microhydropower.com

The MX60 is not compatible with wind turbine applications and OutBack cannot warranty its use in these applications.

MICRO-HYDRO AND FUEL CELL SYSTEMS PERFORMANCE OPTIMIZATION

Micro-hydro and fuel cell systems are different than PV systems, whose Voc output is more subject to change due to weather and time of day. A PV system normally finds its Maximum Power Point voltage between 50-90% of its Voc. The default value for the MX60 is 77% of a solar array's Voc and is displayed on the Park Mpp screen. A microhydro or fuel cell system's MPP voltage can be outside of this range.

The MX60 allows a user to experiment and find more appropriate set points to best capture the MPP voltage. If the output current is under five amps, *Auto Sweep* will park the voltage using whatever percentage value is displayed in the *Park Mpp* screen. Otherwise, *Auto Sweep* begins sweeping the Voc output and works its way down until the optimum percentage of input voltage yields the MPP voltage. If U-Pick % Voc is chosen, the MPP is calculated by whatever value is found in *Park Mpp*, even if it's not the optimal value for determining the MPP voltage. For this reason, OutBack normally suggests leaving the system in *Auto Sweep* mode and the 77% default percentage value, but recommends experimenting with changing this value when a micro-hydro or fuel cell system is in use.

To adjust these values and enhance the performance of these systems, use the MX60 ADVANCED MENU to make changes. To determine your micro-hydro or fuel cell system's best settings for MPP voltage, do the following:

1. Use *Auto Sweep* and record the watts yielded. This value should be in line with your generator capacity.
2. Switch to *U-Pick % Voc* mode and input different *Park Mpp* percentage values, checking the watts value for each. This will require some experimentation.
 - The MX60 can operate at any of the following fixed percentages, selected in the *Park Mpp* screen in the *ADVANCED* Menu selection:
40%, 50%, 67%, 70%, 72%, 75%, 76%, 77%, 78%, 80%, 81%, 83% or 85% of the measured open circuit voltage
 - The user will have to experiment with each of the 13 fixed percentage values to determine an appropriate fixed percentage value. Typical fixed values between 67% up to 78% have provided optimal results; however, each system is different and these fixed percentage values should be used as guidelines only
3. Compare the *Auto Sweep* and *U-Pick % Voc* values and determine which will best fit your system.

In addition to establishing the best mode and percentage values for determining the MPP voltage, a user can also adjust the sweep interval and the range of values the MX60 uses to search for the MPP voltage.

(If necessary, re-enter the system password 141 at any point while optimizing the system's performance.)

ADVANCED MENU (Micro-Hydro) Mpp Range Limit % (Auto Sweep Mode only)

The MX60 searches for the MPP voltage by sweeping the input voltage up to one half (default) of the Voc, which is based on values appropriate for a solar array. Micro-hydro and fuel cell systems can require a broader range, normally on the lower end. Adjusting the lower limit, expressed as **1/2** on the display screen, for FULL allows the MX60 to sweep the input voltage close to the battery voltage instead of 1/2 (or 50%) of the Voc.

This adjustment only affects the initial sweep at the beginning of the day and any subsequent sweeps caused by Auto-Restart or any forced restart of the MX60.

In addition to adjusting the *Mpp Range Limit*, changing the Sweep Interval from its default three-minute setting to zero minutes will also enhance the performance and reliability of some applications' voltage input system.

To adjust the *Lower Mpp Range Limit* and disable the *Sweep Interval*:

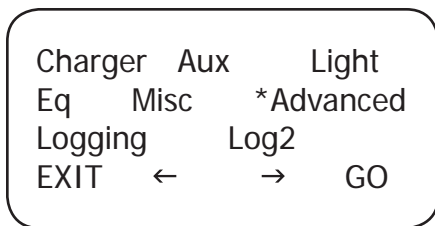

From the *MAIN* Menu, with the asterisk in front of *Advanced*, press the <GO> soft key.



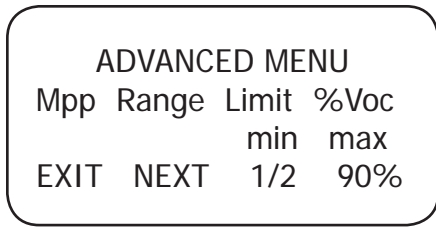

In the *ADVANCED MENU* screen, press the **<NEXT>** soft key until the *Mpp Range Limit % VOC* screen appears. Press the **<1/2>** soft key until *FULL* appears. When finished, press the **<NEXT>** soft key to go to the *Sweep Interval* screen.

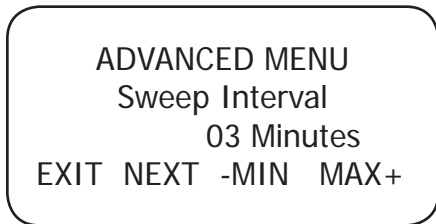

In the *Sweep Interval* screen, press the **<-MIN>** soft key to adjust the *Sweep Interval* from 03 minutes (default) to 00 minutes. Press the **<NEXT>** soft key until the *MPPT Mode* screen appears.

To pick between *Auto Sweep* or *U-Pick % MPPT Mode* and determine the MX60's operating Voc percentage, press the **<NEXT>** soft key until the *MPPT Mode* menu appears.

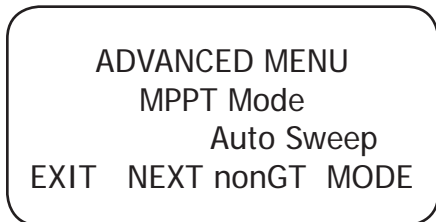

Press the **<MODE>** soft key to interchange between *Auto Sweep* and *U-Pick%Voc* modes. Re-entering the password might be required. Press the **<NEXT>** soft key in the *ADVANCED MENU* until the *Park Mpp* screen appears.

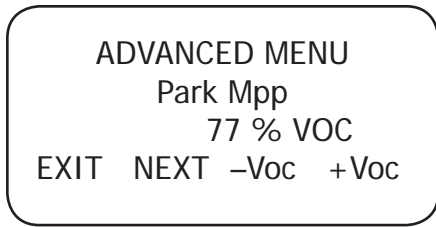

Press the <-VOC> or <+VOC> soft key to select one of the 13 fixed percentage values. *Park Mpp* applies to *Auto Sweep Mode* if the output current is less than 5 amps; *U-Pick* always uses the *Park Mpp* value. Press the <NEXT> soft key until the *MPPT Mode* screen appears.

NOTE: After adjusting the Park Mpp values, the user must perform a mini-sweep to activate these new values.

PV 087 V	Bat 12.0 V
05.0 A	35.8A
Watts 0430	Aux Off
kWHrs 00.0	B-MPPT



In the *STATUS* screen, press the #3 and #4 soft keys simultaneously to perform a Mini-Sweep. The MX60 will track the new *MPP* based on the fixed percentage value. Perform a Mini-Sweep any time a change to the input system or the *Park Mpp* fixed percentage value is changed. In *U-Pick %Voc* mode, press the #3 and #4 soft keys and the *New Voc* is displayed; in *Auto Sweep* mode, press the #3 and #4 soft keys until *Sweeping* is displayed.

A user might want an *MPP* that falls outside of the fixed percentages available in *Park Mpp*. With the MX60, a user can manually adjust these values by single percentage points while observing a change in the instantaneous watts made available with these adjustments.

To manually track and change the *MPP* voltage in either the *Auto Sweep* or *U-Pick %Voc* *MPPT* Modes:

PV 087 V	Bat 12.0 V
05.0 A	35.8A
Watts 0430	Aux Off
kWHrs 00.0	B-MPPT



Press either soft key to adjust PV voltage

Press and hold the #3 soft key to decrease the power point voltage (PV voltage). Press and hold the #4 soft key to increase the power point voltage (PV voltage).

Observe the changes in the *Watts* value to determine whether increasing or decreasing the PV voltage will improve the available power to the system.

Abbreviated Menu Map

Much of the MX60 activity takes place around the *MAIN* screen. From this screen, the user can access other screens to both observe system activity and make adjustments to certain critical functions.

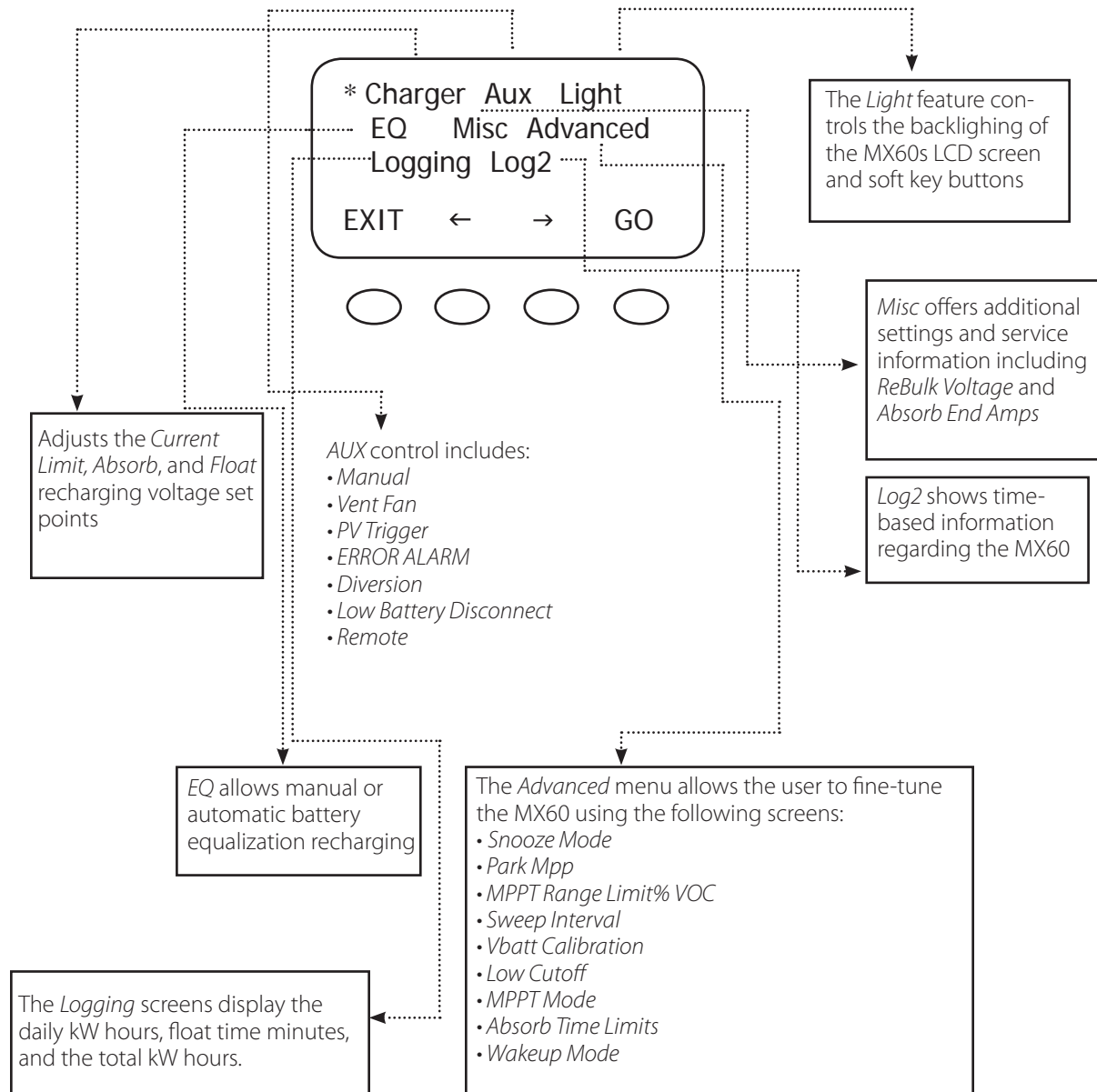

APPLICATION NOTES

OutBack Power System GTFX/GVFX Grid-tie settings

In a GFX/GVFX series inverter, MX60, HUB, and MATE installation set the MX60 to GT mode in the *ADVANCED MENU*. The GT mode allows the GTFX/GVFX series inverter to manage the MX60 *Float* setting ensuring the MX60 is always keeping the battery above the sell voltage of the GTFX/GVFX.

Grid-tie applications (non-OutBack inverter/chargers)

When selling electricity back to the grid, keep the inverter *Sell/Float* voltage below the MX60 *Float* voltage. Appropriate values: 0.5 Volts difference for 24V battery system or 1.0 volt difference for 48V battery systems.

Diversion using hydro or wind power

With wind or hydro generator applications, keep the MX60's diversion voltage slightly above its *Absorb* and *Float* voltages for efficient functioning.

Positive grounded systems

Telcom applications frequently require a positive grounded system. The MX60 switches the POSITIVE PV and battery leads. Keep these separate. If code allows, ground ONLY the battery positive lead in this case. Do not connect the MX60's battery plus to the PV plus input while the MX60 is running. The OutBack HUB cannot be used in a positive grounded system.

Battery temperature compensation with other slopes

The MX60 uses a -5mV per degree C per cell (2V) compensation slope required by UL. For other slopes, you may be able to pick a different battery voltage and change the charger *Absorb* and *Float* voltage settings to achieve a more or less aggressive slope. If going lower in voltage, reduce the *Float* voltage first, since the *Absorb* voltage will not be adjustable below the *Float* voltage setting. If going higher in voltage, increase the *Absorb* setting first before raising the *Float* voltage above the present setting. Here is a table of MX60 compensation based on system voltage for reference:

12V system	-30mV/degree C
24V system	-60mV/degree C
36V system	-90mV/degree C
48V system	-120mV/degree C
60V system	-150mV/degree C

CALLING THE FACTORY FOR ASSISTANCE

When calling OutBack Power for product assistance, please have the following information ready:

- MX60 serial number and software version (The software version can be viewed by pressing the #1 soft key on the *STATUS* screen and then pressing a second time and holding the soft key down.)
- The nominal PV array and battery voltage
- The PV array operating voltage and battery current and any *STATUS* screen operational mode displays, such as *B-MPPT*, *F-MPPT*, *Absorbing*, or *Float*

SPECIFICATIONS

Output Current Rating	→	60 amps continuous @ 25°C ambient
Default Battery System Voltage	→	12, 24, 36, 48 or 60 VDC (adjustable)
PV open circuit voltage	→	150 VDC Maximum (ETL Rating for UL1741 Standard); operational max = 141 VDC temperature corrected VOC
Standby power consumption	→	Less than 1 watt typical
Recharging regulation methods	→	Five stage—Bulk, Absorption, Battery Full, Float, and Equalization
Voltage regulation set points	→	13-80VDC
Temperature compensation	→	With optional RTS sensor 5 millivolts °C per 2V cell
Voltage step down capability	→	Down convert from any PV array voltage within PV voc limits of 141 VDC to any battery system voltage Examples: 72V array to 24V; 60V array to 48V
Digital Display	→	4 line 20 character per line backlit LCD display
Remote Interface	→	RJ45 modular connector Cat 5 cable 8 wire
Operating Temperature Range*	→	-40° to 60°C de-rated above 25°C
Environmental Rating	→	Indoor type 1
Conduit knockouts	→	Two 1" on the back; one 1" on each side; two " on the bottom
Warranty	→	Two years parts and labor, optional extended warranty available
Dimensions	→	MX60—13.5"H x 5.75"W x 4"D Boxed—18"H x 11W x 8"D
Weight	→	MX60—12 pounds Boxed—15 pounds

*The MX60's maximum current output at 25°C is 60 amps. In higher ambient temperatures, the MX60's current limit should be reduced in order to prevent possible damage to the unit. Realistically, given that the solar array also reduces its current output when the ambient temperature increases, a user will probably never have to adjust the MX60's current limit. To do so, go to the *STATUS* screen and choose the *Charger* function.

```

*Charger  Aux  Light
EQ      Misc  Advanced
Logging  Log2
EXIT ←      →  GO
  
```

Press the <GO> soft key after aligning the asterisk in front of the selected menu choice.



Press ← or → to move the asterisk "*" to the left of the Charger function.

```

LIMIT  ABSORB  FLOAT
Amps   Volts    Volts
*60.0  14.4      13.6
EXIT →      -      +
  
```

Press → to move the asterisk in front of the Amps selection (default is 60.0) and adjust this figure using the "-" and "+" soft keys using the figures in following MX60 Current vs. Temperature Chart. *Remember to change the current limit when the ambient temperature changes.*



MX60 Current Vs Temperature (all temps Celsius)

Ambient Temperature	Maximum Current (amps)
25	60.00
30	57.45
35	54.77
40	51.96
45	48.99
50	45.83
55	42.43
60	38.73
65	34.64
70	30.00
75	24.49
80	17.32

Table 1

An easy de-rating rule to use in lieu of the above table is "1 amp per degree C." Altitude should also be factored into de-rating. Use the following table to determine altitude-related values.

Altitude Meters/Feet	Factor
0 / sea level	1.00
1000 / 3,000	0.95
1500 / 5,000	0.90
2000 / 7,000	0.86
3000 / 10,000	0.80
3500 / 12,000	0.75

Table 2

MX60 EFFICIENCY vs. INPUT POWER GRAPH

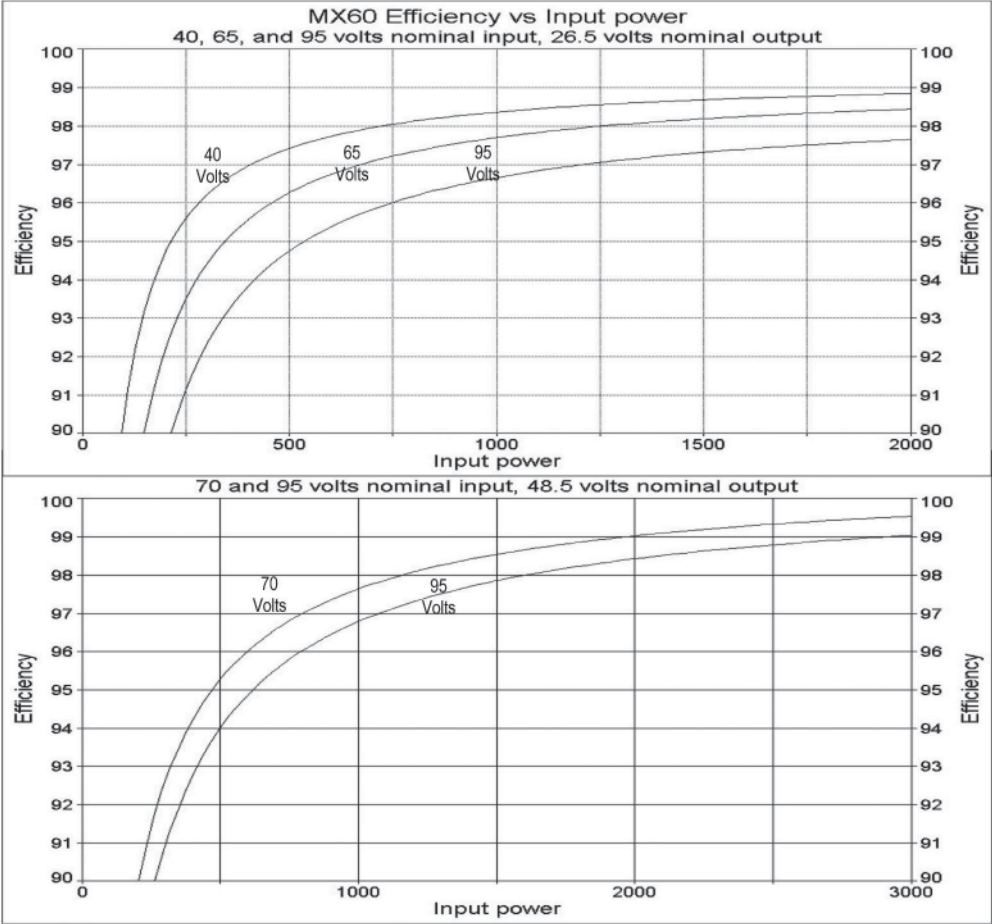

Figure 6 24V and 48V Battery System Efficiency Curve

UNDERSTANDING THE VARIOUS OPERATIONAL MODES

The MX60 modes of operation will change occasionally during the day based on the PV array output and the battery system state of charge. The MX60 operating modes are displayed at the bottom right hand corner of the STATUS screen.

Absorb-EX There is an external DC source other than solar keeping the battery above the Absorb set point. The MX60 will not be producing power.

Absorbing The MX60 is in the Absorb (constant voltage) charge stage, regulating the battery voltage at the Absorb set point (modified by battery temperature compensation if installed). During this cycle, the ChgT counter in the Misc menu is counting down towards zero. If the system cannot regulate the battery voltage at the Absorb voltage set point, then the MX60 reverts back to the Bulk charge stage, display B-MPPT, and the ChgT counter will start counting up again towards the MAX Absorb time set point or until the Absorb target is met.

AutoStart (Auto Re-Start) Mode 1—Once every 1.5 hours in Bulk cycle and in Mode 2, once every 1.5 hours in the Bulk, Absorb and Float recharging modes, the MX60 will start over from sleeping and re-sweep (full sweep) and re-calibrate the current sensor. Mode 0 is disabled completely. It is recommended that this mode be left to mode 2, Auto Re-Start in all 3 recharging cycles. (See Log2 screen)

Bat>Abs When the PV voltage exceeds the battery voltage by 2V and the battery voltage exceeds the absorb set point, the MX60 has no need to recharge. This can also unintentionally occur if the user inputs a lower battery voltage than is actually in use (e.g. establishing set points for a 12V system when a 24V battery bank is used). In this case, the MX60 will always sense a higher (24V) voltage than a 12V system would require for recharging.

Bat Full There is an external DC source other than solar keeping the battery above the Float set point. The MX60 is transitioning from Absorb (upper target voltage) to Float (lower target voltage) or it will not be producing power.

B-MPPT The MX60 is in Maximum Power Point Tracking mode trying to regulate the battery voltage towards the Absorb voltage set point. If the MX60 is in the Bulk charge stage, the Charge Timer (ChgT), will count up to the max Absorb time.

Bat Tmp Err The battery temperature sensor is shorted or damaged.

EQ 0:00 This is the time elapsed in hours and minutes since the Equalization voltage was met. If the EQ voltage set point is not maintained, the controller will revert back to EQ-MPPT – the EQ timer will pause until the batteries are regulated at the EQ target again. The paused time can be viewed in the Log2 menu.

EQ DONE Once the set EQ time, (between 1 and 7 hours), has successfully completed, EQ DONE will be displayed either until a button is pressed, or the next morning's wakeup. The MX60 will transition to Float cycle at the end of the EQ cycle.

EQ-MPPT The equalization process has started and the MX60 is trying to regulate towards the Equalization voltage set point. EQ is *not* battery temperature compensated. After the EQ voltage has been reached, EQ 0:00 will be displayed along with the EQ time in hours and minutes. The AC/DC loads should be turned off and the battery should be charged so the MX60 can reach the EQ voltage set point. Otherwise, the MX60 may not reach or maintain the EQ cycle.

Float The MX60 is in the Float charge stage and is regulating the battery at the Float voltage set point. If the system cannot keep up with the Float voltage set point, (e.g. AC and/or DC loads are on), the MX60 will employ the MPPT function, display F-MPPT, and try its best to regulate the batteries to the Float set point.

F-MPPT The MX60 is in Maximum Power Point Tracking mode trying to regulate the battery voltage towards the Float voltage set point. **Note:** Charge Timer (ChgT) is inactive in the Float state.

GT Mode In a system with an OutBack FX GT-series Inverter/Charger, HUB *and* MATE, the MX60 will display GT Mode if and only if the inverter is in Sell mode *and* the MX60 is in Bulk (B-MPPT) or Float (F-MPPT) cycle. This is also a good indicator for establishing proper grid-tie mode communication between the FX GT-Series Inverter(s) and MX60.

High Voc This indicates the PV array's open circuit voltage is too high for the controller to safely operate. This should only occur with systems using 72 VDC nominal PV arrays in very cold temperatures (below 50 F / -150 C). The controller will automatically restart operation once the PV array's open circuit voltage falls to a safe level (141 VDC). The amount of time required to reset is dependent on the module type, ambient temperature, and the amount of sunlight directly on the PV array. Normally, the controller starts in the morning within a few minutes of the PV array being in direct sunlight.

Low Light / Snoozing During the initial sweep (*see Wakeup and Sweeping*), if it is determined to be too late (or too early) in the day, the MX60 will display Low Light for a few seconds and then display Snoozing for 5 minutes (default). This reduces energy usage and unnecessary powering of the MX60. This message is also displayed in extremely cloudy weather. The Snoozing mode can be disabled and has two basic modes to choose from: one based on the speed of the PV to charge the input capacitors and the second looks at the initial wakeup sweep current to see if it reached the Low cutoff (default) current set point.

MX 2 Hot (Very rare) Either the MX60 is too hot or its internal temperature sensor is shorted. If this message appears, carefully check if the MX60's heat sink is extremely hot. The heat generated by the MX60, and therefore its losses, is proportional to input voltage times output current. Avoid installing the MX60 in direct sunlight to help control its operating temperature.

New Voc The MX60 is acquiring a new open circuit panel voltage (Voc) periodically in the UPick MPPT mode or it found a new Voc during an initial sweep.

Re-Cal There are certain abnormal conditions that can confuse the current measuring method in the MX60. When and if one happens, the MX60 will temporarily stop and re-calibrate. This may happen because of negative current, i.e., current coming out of the input terminals instead of into the input terminals, or a tripped PV breaker. A new Voc is also acquired during a Re-Cal.

Sleeping The PV voltage is two volts less than the battery voltage. This may also appear during the day when the MX60 is transitioning between certain states, or due to other conditions.

Sweeping In Auto-Sweep MPPT mode, the MX60 is either (1) doing an initial sweep of the panel voltage from Voc towards battery voltage after wakeup, (2) doing a periodic mini-sweep to stay within its acquired Maximum Power Point voltage, or (3) sweeping to maintain the current limit. Below 5 amps of battery output current, "Sweeping" briefly flashes on the display as the MX60 operates at the Park Mpp voltage.

SysError (Very rare) System Error indicates an internal non-volatile memory error. The unit will stop operating when this message is displayed. Call the factory if you see this message.

Unloaded The battery terminals abruptly unload. *Unloaded* is displayed if the battery breaker trips while MPPTing or the battery voltage is set too low.

Wakeup As the PV open circuit voltage (Voc) rises above the battery system voltage by two volts, the MX60 prepares to deliver power to the batteries. During this period, the MX60 is calculating the pulse width modulation (PWM) duty cycles, turning on power supply voltages in the proper sequences, and making internal calibrations. At wakeup, the MX60 closes its relays and then starts sweeping the input voltage (the "initial" sweep) towards the battery voltage. At dawn and dusk this may happen many times until there is (or is not) enough power from the PV array to keep going. Wakeup is also a time when the MX60 acquires a new Voc.

Zzzz... At night (3 hours of Sleeping) the MX60 will display Zzzz... until the next wakeup. At the next wakeup, (usually the next morning), the daily statistics, (AmpHours, KWh, etc.), will accumulate into the total statistics and then the displayed daily statistics will clear. A Bulk charge will automatically initiate at the next Wakeup.

MATE-DISPLAYED MX60 STATUS MODE Screens

The MX60 *STATUS MODE* Screens displayed on the optional OutBack MATE include *MODE*, *METER*, and *SET* (SETPOINT). In *STATUS* Mode, these MX functions can be viewed by the MATE, but not changed. Please see the MATE Installation and User Manual for more information.

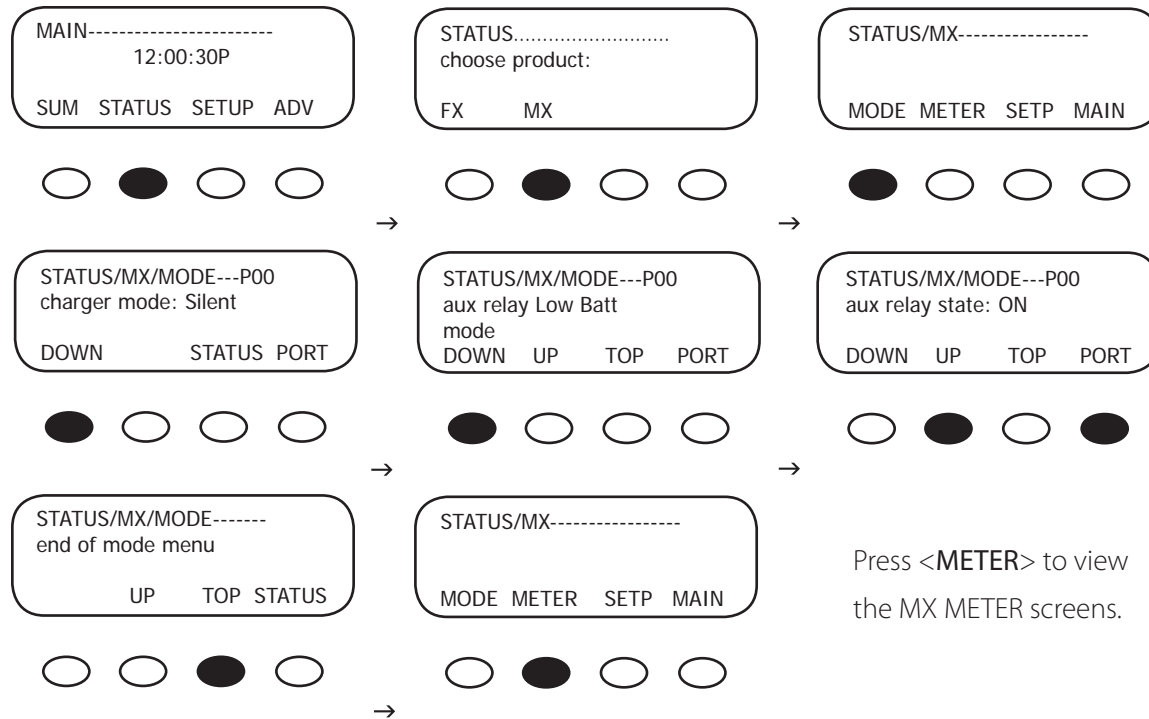

MX MODE Screens

- *charger mode*: displays one of five charging stages (*Bulk*, *Absorption*, *Float*, *Silent*, or *Equalization*)
- *aux relay mode*: displays one of eight MX60 AUX modes (*Manual*, *Vent Fan*, *PV Trigger*, *Float*, *ERROR ALARM*, *Diversion*, *Low Batt(ery) Disconnect*, or *Remote*)
- *aux relay state*: indicates if the AUX is *ON* or *OFF*

MATE-DISPLAYED MX60 STATUS METER Screens

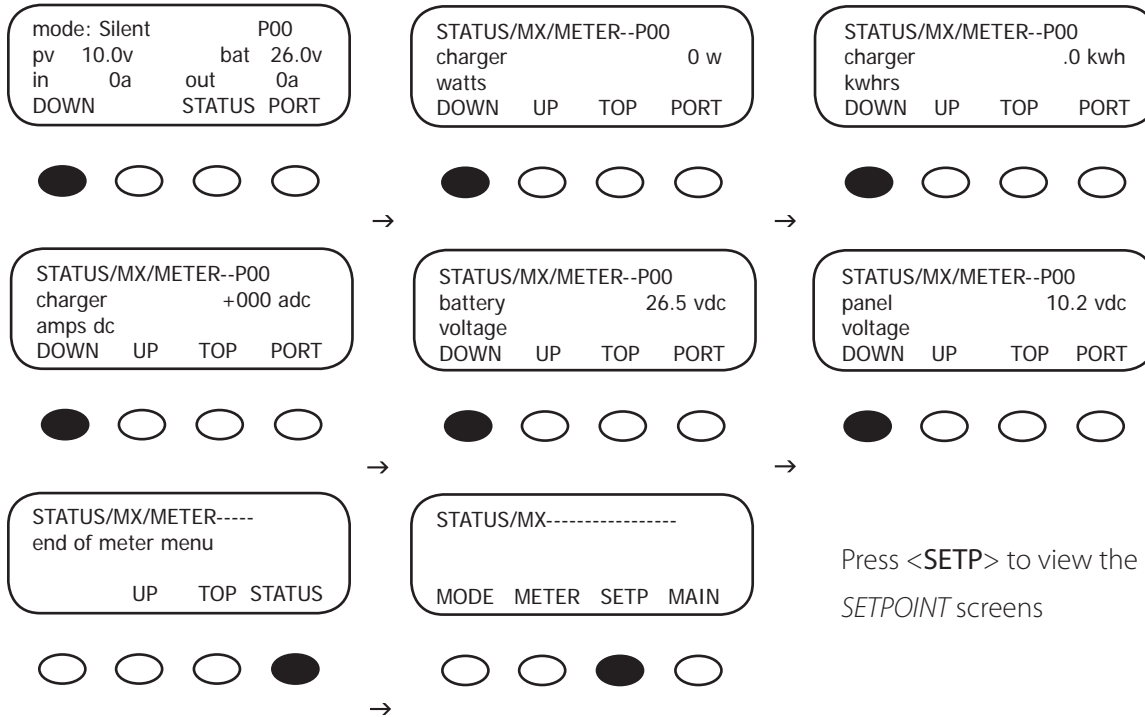

MX METER Screens

- *mode/pv/in/bat/out*: displays the charger mode, the PV array voltage, the incoming PV amps, the battery voltage, and the outgoing amps to the battery
- *charger watts*: charger output measured in watts
- *charger kWhrs*: kilowatt hours produced in the last 60 minutes by the MX60
- *charger amps dc*: the amount of amperage the MX60 is sending to the battery
- *battery voltage*: current battery voltage
- *panel voltage*: current voltage from the PV array

MATE-DISPLAYED MX60 STATUS SETPT (SETPOINT) Screens

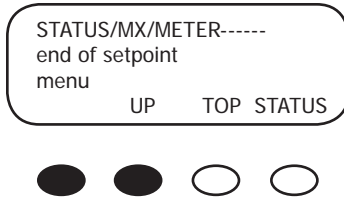
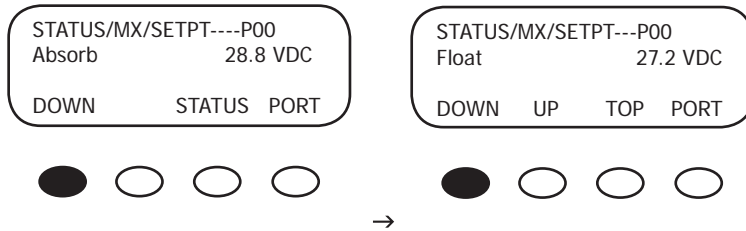

Press the first two soft keys simultaneously to return to the *MAIN* Menu or press <STATUS> and then press <MAIN> on the *STATUS* screen.

MX SETP(OINT) Screens

- *Absorb*: displays the voltage that initiates and maintains the *Absorb* cycle
- *Float*: displays the voltage that begins the *Float* cycle and is maintained during this cycle

TROUBLESHOOTING GUIDE

MX60 does not boot/power-up (blank LCD)

Be sure to check out the OutBack customer and user forum at www.outbackpower.com/forum/ for more MX60 information.

- Check the battery connection and polarity.
 - ▶ Reverse polarity or an improper connection will cause power-up issues.
- Check the battery breaker.
 - ▶ Ensure that the battery breaker is sized appropriately.
- A battery voltage below 10.5 VDC may not power up the MX60 (measure the battery-side of the Four- Position Terminal Block).
- If the MX60 still does not power up, call the factory for additional support.

MX60 is always SLEEPING

- If the battery voltage is at or above the *ABSORB* voltage set point (compensated *ABSORB* voltage), the MX60 will not wake up.
- The PV voltage has to be at least two volts greater than the battery voltage for the initial wakeup.
- Check the PV array breaker (or fuse).
- Confirm the PV array breaker (or fuse) is sized appropriately.
- Which State (in *MISC* Menu) is it at? Is it transitioning between 00 and 01? Is it in *GT* mode and connected to a MATE?
 - ▶ *GT* mode is only applicable with a HUB 4 or HUB 10 installations with a grid-tie compatible MATE.
- Does the PV array voltage on the display rise with the PV breaker OFF, but reads 000 with the PV breaker ON?
 - ▶ If so, the PV array polarity connection on the MX60 maybe reversed or the PV lines could be shorted.
- Does the PV voltage still read 000 with the PV breaker off after a minute?
 - ▶ Call the factory for support.
- Have you checked the short circuit current of the PV array?
 - ▶ Use a multi-meter to determine if a short circuit current is detected. The short circuit current test will not harm the array.

MX60 not producing expected power

- Clouds, partial shading, or dirty panels can cause poor performance.
 - ▶ The lower current limit set point in the *Charger* menu will yield a loss of power or poor performance symptoms.
- Are the batteries charged? Is the MX60 in the *ABSORB* or *FLOAT* stage? If either case is true, the MX60 will produce enough power to regulate the voltage at the *ABSORB* or *FLOAT* set point voltage, therefore, requiring less power in these modes.
- What is the short circuit current of the PV array? Use a multi-meter to determine if a short circuit current is as expected. There might be a loose PV array connection.
- If the PV array voltage close to the battery voltage, the panels could be warm/hot causing the Maximum Power Point to be at or lower than the battery voltage.
- If the *Sweep Interval* is set to 00 mins, the MX60 will not periodically find the Maximum Power Point of the array. A *Sweep Interval* of seven to ten minutes is suggested

MX60 is not equalizing

- Has the *EQ* cycle been initiated?
 - ▶ In the *EQ* Menu, press <START> to begin process. When the *EQ* cycle has been initiated, *EQ-MPPT* will be displayed.

- The *EQ* cycle has been initiated, but the battery is not equalizing.
 - ▶ The *EQ* cycle will begin when the target *EQ* set point voltage has been reached. A small array or cloudy weather will delay the *EQ* cycle. Accordingly, running too many AC and/or DC loads will delay the *EQ* cycle, too.
- An *EQ* set point that is too high relative to the battery voltage will delay the *EQ* cycle.
- If the PV array voltage is close to the battery voltage, the panels could be warm/hot causing the Maximum Power Point to be at or lower than the battery voltage which can delay the *EQ* cycle.

MX60 Sweeping frequently

- A short sweep interval time will cause the MX60 to sweep frequently. A sweep interval of seven to ten minutes is recommended.
- When the current limit set point is achieved, the MX60 will continue to sweep to maintain the targeted current limit.

MX60 Battery Temperature Compensated Voltage

- Only the OutBack RTS (remote temperature sensor) can be used with the MX60.
- The battery voltage can rise above the *ABSORB* and *FLOAT* voltage set points if the battery temperature is < 77° F or fall below the *ABSORB* and *FLOAT* voltage if the battery temperature is > 77° F.
- Why does the MX60 show *BatTmpErr* on the *STATUS* screen?
 - ▶ The RTS is faulty or damaged. Disconnect the RTS from the RTS jack to resume normal operation.

MX60 Internal Fan

- The internal fan will only run when the internal temperature has reached approximately 115° F. The internal fan will run as needed. In the *MISC* Menu, the fan will run if and only if the value of *PCB* is lower than the value **350**. Note that the value 350 represents a temperature count value; it does not itself equal 350° F.

MX60 is beeping

- When the MX60 is in *Extended Play* mode, the array is very hot, and the MPP is close to the battery voltage, beeping can occur. To disable the *Extended Play* feature, go to the *MAIN* Menu and press and hold the #1 soft key until the MX60's software version appears on the screen. Continue pressing the #1 soft key and press the #3 soft key at the same time until *X Off* displays on the screen. To reactivate *Extended Play*, repeat these steps and hold the #3 soft key until *X On* displays. *Extended Play* is meant to optimize the performance of a hot array, but isn't critical to efficient MX60 operations.

TYPICAL ARRAY SIZING GUIDE

Below is a list of recommended array sizing for the MX60 for various nominal voltage batteries:

Nominal Battery Voltage	Recommended Array Size (in watts, Standard Test Conditions)
12 V	800 W
24 V	1600 W
36 V	2400 W
48 V	3200 W
60 V	4000 W

The MX60 PV MPPT Charge Controller is capable of an input open circuit voltage (Voc) of up to 150 VDC. Cooler climates can cause the Voc to rise above the panel Voc rating. In climates that observe temperatures less than approximately 5° F, a Voc greater than 125 VDC is **not** recommended.

When sizing an array, it is recommended that the nominal array voltage be higher than the nominal battery voltage. Below is a list of recommended nominal array sizing:

Nominal Battery Voltage	Nominal Array Voltage (recommended)
12 V	24 V (or higher)*
24 V	36 V (or higher)*
36 V	48 V (or higher)*
48 V	60 V (or higher)*
60 V	60 V (low temp is less than 5° F) or 72v (low temp is greater than 5° F)

* When sizing an array to charge controller with a distance of 70 feet or greater, OutBack recommends the nominal array voltage be slightly higher than the *recommended* nominal array voltage. Example: A 36 VDC nominal array recharging a 12 V nominal battery with an array to charge controller distance of about 70 feet or greater. Sizing the nominal array voltage higher than the nominal battery voltage ensures that the Maximum Power Point is always above the battery voltage. The Maximum Power Point will decrease as the panels warm up, thus lowering the output of the array. The MX60 Charge Controller will not be able to boost the output if the Maximum Power Point of the array is at or lower than the battery voltage.

STANDARD vs. AUSTRALIAN DEFAULT SETTINGS

The Australian version MX60 has a few default settings that differ from the Standard version default settings. However, there are no differences in performance and efficiency between the two versions. The Standard and Australian version can be identified as follows:

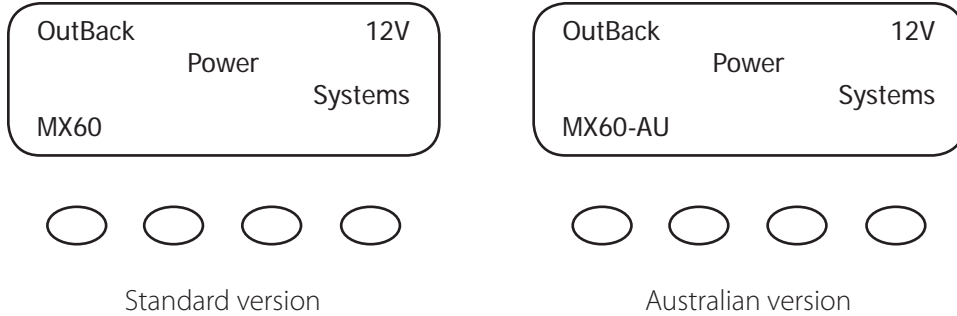

Below are a few default setting differences between the Standard and Australian version.

Settings	Standard			Australian		
	Amps	Absorb	Float	Amps	Absorb	Float
Charger						
12 V	60	14.4 V	13.6 V	60	14.4 V	13.8 V
24 V	60	28.8 V	27.2 V	60	8.8 V	27.6 V
36 V	60	43.2 V	40.8 V	60	43.2 V	41.4 V
48 V	60	57.6 V	54.4 V	60	57.6 V	55.2 V
60 V	60	72.0 V	68.0 V	60	72.0 V	69.0 V
Equalize		Equalize Volts			Equalize Volts	
12 V		14.4			14.7	
24 V		28.8			29.4	
36 V		43.2			44.1	
48 V		57.6			58.8	
60 V		72.0			73.5	
Equalize Time		01 Hours			03 Hours	

To meet NEC compliance, the largest PV array that can be connected to the MX60 should have a rated short-circuit current of 48 amps. The following charts show the maximum distance of various gauge two-conductor copper wire from the PV array to the MX60 with a 1.5% maximum voltage drop. Temperature and conduit fill corrections may be required. Using a higher voltage PV array with a low voltage battery system allows you to use a much smaller wire size or go up to 5 times as far with the same gauge wire.

Wire Distance Chart

		Wire Gauge							METRIC
		#8	#6	#4	#2	#1/0	#2/0	#4/0	
12 Volt PV Array 16V MPP Typical 12 Volt Battery System	Amps								
	8	22	35	57	90	145	180	290	#8...8.37mm ²
	10	18	28	45	72	115	145	230	#6...13.30mm ²
	15	12	19	30	48	76	96	150	#4...21.15mm ²
	20	9	14	22	36	57	72	116	#3...26.7mm ²
	30	6	9	15	24	38	48	77	#2...33.6mm ²
	40	4	7	11	18	29	36	56	#1/0...53.5mm ²
	50	3	5	9	4	23	29	46	#2/0...67.4mm ²
									#4/0...107mm ²
.....									
		Wire Gauge							
		#8	#6	#4	#2	#1/0	#2/0	#4/0	
24 Volt PV Array 32V MPP Typical 12 or 24 Volt Battery System	Amps								
	8	45	71	114	180	290	360	580	
	10	36	57	91	145	230	290	460	
	15	24	38	60	96	153	192	300	
	20	18	29	45	72	115	145	232	
	30	12	19	30	48	77	97	154	
	40	9	14	23	36	58	72	112	
	50	7	11	18	29	46	58	86	
.....									
		Wire Gauge							
		#8	#6	#4	#2	#1/0	#2/0	#4/0	
48 Volt PV Array 64V MPP Typical 12, 24 or 48 Volt Battery System	Amps								
	8	90	142	228	360	580	720	1160	
	10	72	114	182	290	460	580	920	
	15	48	76	120	192	306	384	600	
	20	36	58	90	144	230	290	464	
	30	24	38	60	96	154	194	308	
	40	18	28	46	72	116	144	224	
	50	14	22	36	58	92	116	172	

60 Volt PV Array 80V MPP Typical 12, 24 or 48 Volt Battery System	Amps	Wire Gauge						
		#8	#6	#4	#2	#1/0	#2/0	#4/0
	8	112	177	285	450	725	900	1450
	10	90	142	227	362	575	725	1150
	15	60	95	150	240	382	480	750
	20	45	72	112	180	287	362	580
	30	30	47	75	120	192	230	385
	40	22.5	35	57	90	145	180	280
	50	17.5	27	45	72	115	145	215

METRIC
#8...8.37mm ²
#6...13.30mm ²
#4...21.15mm ²
#3...26.7mm ²
#2...33.6mm ²
#1/0...53.5mm ²
#2/0...67.4mm ²
#4/0...107mm ²

72 Volt PV Array 96V MPP Typical 12, 24 or 48 Volt Battery System	Amps	Wire Gauge						
		#8	#6	#4	#2	#1/0	#2/0	#4/0
	8	140	221	356	562	906	1125	1812
	10	113	178	284	453	719	906	1437
	15	75	119	188	300	478	600	937
	20	56	90	140	225	359	452	725
	30	37	59	94	150	240	287	481
	40	28	44	71	112	181	225	350

WIRE AND DISCONNECT SIZING

The MX60 has a 60 amp current output limit (default) and is listed to operate continuously at 60 amps depending on the nominal PV array voltage and the nominal battery voltage. There is no 80% de-rating as required by the NEC* for fuses, conductors, and most circuit breakers.

The MX60 is a buck type converter and cannot boost the output current when the PV array peak power point voltage is at or below the battery voltage as may happen on hot days in 24 VDC PV and a 24 VDC battery system or a 48 VDC PV and a 48 VDC battery system.

To meet minimum NEC requirements (NEC 310.15, 690.8, 9), the output conductor should have an ampacity of 75 amps after any temperature and conduit fill corrections. This would normally indicate that the output conductors be 4 AWG (5.83 mm), but a larger size may be required if there are temperature and/or conduit fill corrections required. With an output conductor rated at 75 amps (1.25 X the continuous output current), the OutBack OBB-60 breaker—rated for continuous 100% duty at 60 amps—can be used to provide the code-required disconnect and output circuit over current protection.

The PV array output connected to the MX60 input may be as high 60 amps, but at this current level, there is very little (if any) current boosting or maximum power-point tracking due to the 60-amp output current limit. Additionally, the input current may exceed 60 amps on bright sunny days and any excess power would be lost. The size and ampacity of the input conductors must be selected to handle 1.56 times the short-circuit current of the PV array. Any disconnect or circuit breaker connected to the input conductors must also be rated at 1.56** times the short-circuit current for the PV array unless the breaker is rated for 100% duty in its enclosure. If that is the case, the circuit breaker may be rated at 1.25 times the PV array short-circuit current. OutBack OBB-XX breakers are 100% duty rated breakers.

In terms of NEC compliance and the MX60's 60-amp output rating, the largest PV array it can connect to should have a rated short-circuit current of 48 amps. This meets NEC requirements and allows the MX60 to perform maximum power-point tracking functions. The following charts show maximum distance in feet of various gauge two-conductor copper wire from the PV array to the MX60 with a 1.5% maximum voltage drop. Temperature and conduit fill corrections may be required.

*When NEC does not apply, see local code requirements.

**UL requires I_{sc} (short circuit current) to be multiplied by 125% for the conductor rating.

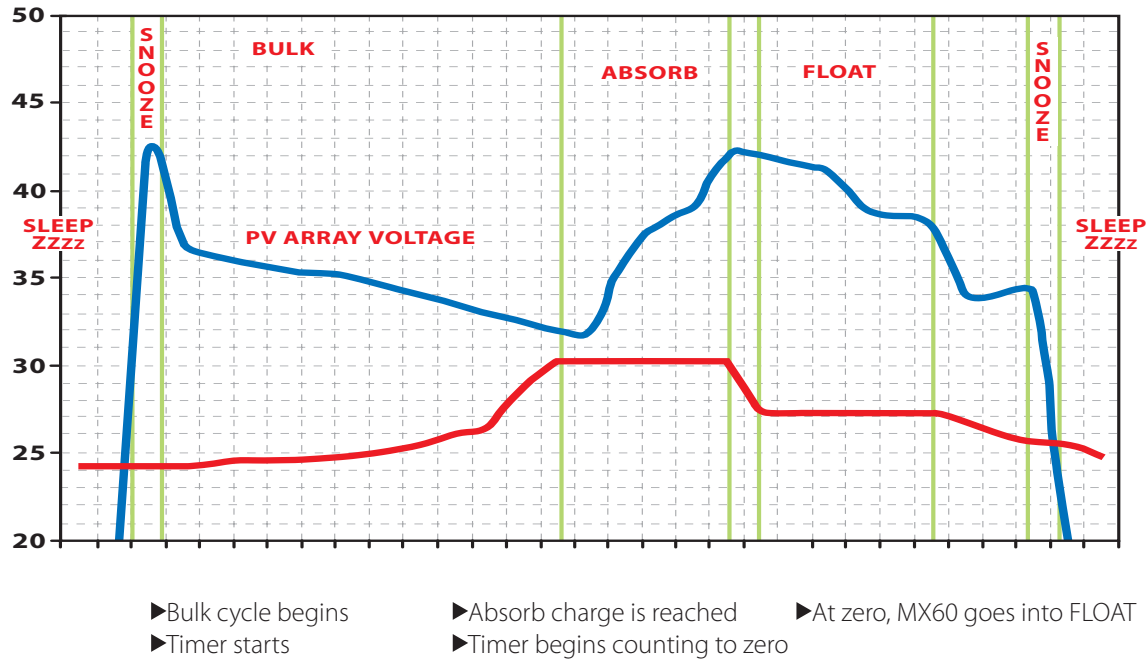

Figure 7 MX60 MULTI-STAGE BATTERY CHARGING

The MX60 Charge Controller is a sophisticated, multi-stage battery charger that uses several regulation stages to allow fast recharging of the battery system while ensuring a long battery life. This process can be used with both sealed and non-sealed batteries. The MX60 has a preset recharging voltage set points (Absorb & Float) for the selected nominal battery voltage, however, always follow the battery manufacturer's recommended charging regulation voltages. The MX60 charging regulation stages correspond to the chart in Figure 7.

BULK cycle provides the maximum power to the battery –the voltage increases while recharging.

A Bulk cycle is automatically initiated when the battery voltage is below the Absorb and Float* recharge voltage set points. The Bulk cycle will continue until the Absorb voltage set point is achieved. "BMPPT" is displayed on the screen.

ABSORBING cycle limits the amount of power going to the battery—the voltage is held constant.

The Absorb cycle will continue for the duration of the Bulk cycle or until the 2 hour (default) Absorb time limit is reached. For example, if a Bulk cycle takes 1 hour to reach the Absorb voltage set point, then the Absorb cycle will continue for 1 hour as well. However, if a Bulk cycle takes 3 hours to reach the Absorb voltage set point, then the Absorb cycle will continue for 2 hours only. A Bulk cycle will be re-initiated if the battery voltage is not sustained at the Absorb voltage set point. "Absorbing" is displayed on the screen at this time.

FLOAT cycle reduces the recharging voltage to prevent overcharging of the batteries.

A Float cycle follows after the Absorb cycle is completed; "Float" is displayed on the screen. The MX60 **will not** re-initiate another Bulk cycle if the Float voltage set point is not sustained*. F-MPPT is displayed. However, it will continue to recharge the battery until the Float voltage set point is reached.

***NOTE:** A Bulk cycle can be auto-initiated if the battery voltage falls below the Float voltage set point and the Re-Bulk (ReBV) voltage option is set.

BATTERY TEMPERATURE COMPENSATED VOLTAGE SET POINT

The temperature of a battery has an impact on the recharging process—in higher ambient temperatures, the regulation set points (Absorb & Float) need to be reduced to prevent overcharging of the batteries. In lower ambient temperature conditions, the voltage regulation set points need to be increased to ensure complete recharging of the batteries.

The default charger settings of the MX60 are based on typical lead acid battery systems. *Always ensure that the Absorb & Float voltage regulation set points are set to the recommended battery manufacturer's recharging regulation voltages.*

Non-Battery Temperature Compensated System

If a battery remote temperature sensor is not available the Absorb and Float voltage regulation set points can be adjusted for the expected weather conditions. The following table shows the appropriate adjustments for both Absorb and Float voltage regulation set points for weather conditions above or below 77° F / 25° C

EXPECTED TEMPERATURE	ADJUST SETPOINT	12 V	24 V	48 V
Average = 95° F / 35° C	Subtract	0.30 V	0.60 V	1.20 V
Average = 86° F / 30° C	Subtract	0.15 V	0.30 V	0.60 V

Average = 68° F / 20° C	Add	0.15 V	0.30 V	0.60 V
Average = 59° F / 15° C	Add	0.30 V	0.60 V	1.20 V

Battery Temperature Compensated System

A battery remote temperature sensor (RTS) will **automatically** compensate the Absorb & Float voltage **relative** to the Absorb and Float set points in the *Charger* menu. Please reference page 38 of this manual for adjusting the upper and lower battery compensated limits.

SUGGESTED BATTERY CHARGER SET POINTS

The battery manufacturer should provide you with specific instructions on the following maintenance and voltage set point limits for the specific batteries. The following information can be used when the manufacturer's information is not available.

SEALED LEAD ACID – AGM / GEL	12 V	24 V	48 V
ABSORB voltage set point	14.4 V	28.8 V	57.6 V
FLOAT voltage set point	13.4 V	26.8 V	53.6 V
NON-SEALED LEAD ACID	12 V	24 V	48 V
ABSORB voltage set point	14.8 V	29.6 V	59.2 V
FLOAT voltage set point	13.8 V	27.6 V	55.2 V

NOTE: Higher settings can be used with non-sealed batteries, but water consumption will be greater and excessive temperatures when recharging may occur.

Battery Voltage and State of Charge

A battery's voltage can be used as a guideline to estimate the amount of power stored in the battery that is available for use. When referencing the battery voltage on the display, be sure the battery is not under significant recharging or heavy loads. Otherwise, the DC voltage is not reflective of the battery state of cycle. Often the best time to check the battery voltage is in the morning (pre-charging) or at night (postcharging), with the battery disconnected from charging sources and loads and a rest for at least three hours.

Operation of a battery below 50% state of cycle will adversely affect the long term health of the battery system and will result in premature failure. Keeping the battery above the 50% level and recharging it completely once a month will ensure proper operation and good performance.

STATE OF CHARGE

Nominal Battery Voltage	Charged	Good (~75%)	Average (~50%)	Low (~25%)	Discharged
12 V	over 12.6 V	12.3 V	12.0 V	11.7 V	under 11.4 V
24 V	over 25.2 V	24.6 V	24.0 V	23.4 V	under 22.8 V
48 V	over 50.4 V	49.2 V	48.0 V	46.8 V	under 45.6 V
60 V	over 63.0 V	61.5 V	60.0 V	58.5 V	under 57.0 V

OWNER'S SYSTEM INFORMATION

Date of Purchase: _____

Vendor: _____

Date of Installation: _____

Installer: _____

Installer Contact Information: _____

MX60 Serial Number: _____

Battery Voltage: _____

PV Voltage: _____

PV Module Type and Manufacturer: _____

Array Wattage: _____

NOTES: _____

EU DECLARATION OF CONFORMITY

According to ISO / IEC Guide 22 and EN 45014

Product Type: Photovoltaic Charge Controller

Product Model Number: MX60

This product complies with the following EU directives:

Electromagnetic Compatibility 89/336/EEC, "Council Directive of 3 May 1989

On the approximation of the laws of member States relating to Electromagnetic compatibility"

Low Voltage Directive 73/23/EEC, "Council Directive of 19 February 1973 on the harmonization of the laws of Member States relating to electrical equipment for use within certain voltage limits"

The compliance of the above mentioned product with the directives and the following essential requirements is hereby confirmed:

Emissions Immunity Safety

EN 61000-6-3 (2001) EN 61000-6-1 (2001) EN 60335-1 Battery Chargers

EN 60335-2-29 Battery Chargers

All associated technical files are located in the Engineering Department at OutBack Power Systems Inc., Arlington, Washington, USA.

As the manufacturer, we declare under our sole responsibility that the above-mentioned product complies with the above-named directives.



19009 62nd Ave. NE
Arlington, WA. 98223 USA
(360) 435-6030



TWO YEAR LIMITED WARRANTY INFORMATION

MX60 Products

OutBack Power Systems, Inc. ("OutBack") provides a two year (2) limited warranty ("Warranty") against defects in materials and workmanship for its MX60 products ("Products") if installed in fixed location applications.

For this Warranty to be valid, the Product purchaser must complete and submit the applicable Product registration card within ninety (90) days of the eligible Product's first retail sale. This Warranty applies to the original OutBack Product purchaser, and is transferable only if the Product remains installed in the original use location. The warranty does not apply to any Product or Product part that has been modified or damaged by the following:

- Installation or Removal;
- Alteration or Disassembly;
- Normal Wear and Tear;
- Accident or Abuse;
- Corrosion;
- Lightning;
- Repair or service provided by an unauthorized repair facility;
- Operation contrary to manufacturer product instructions;
- Fire, Floods or Acts of God;
- Shipping or Transportation;
- Incidental or consequential damage caused by other components of the power system;
- Any product whose serial number has been altered, defaced or removed; or
- Any other event not foreseeable by OutBack.

OutBack's liability for any defective Product, or any Product part, shall be limited to the repair or replacement of the Product, at OutBack's discretion. OutBack does not warrant or guarantee workmanship performed by any person or firm installing its Products. This Warranty does not cover the costs of installation, removal, shipping (except as described below), or reinstallation of Products.

To request warranty service, you must contact OutBack Technical Services at (360) 435-6030 or support@outbackpower.com within the effective warranty period. If warranty service is required, OutBack will issue a Return Material Authorization (RMA) number. A request for an RMA number requires all of the following information:

1. Proof-of-purchase in the form of a copy of the original Product purchase invoice or receipt confirming the Product model number and serial number;
2. Description of the problem; and
3. Shipping address for the repaired or replacement equipment.

After receiving the RMA number, pack the Product(s) authorized for return, along with a copy of the original purchase invoice and warranty certificate, in the original Product shipping container(s) or packaging providing equivalent protection and mark the outside clearly with the RMA number. The sender must prepay all shipping charges, and insure the shipment, or accept the risk of loss or damage during shipment. OutBack is not responsible for shipping damage caused by improperly packaged Products, the repairs this damage might require, or the costs of these repairs. If, upon receipt of the Product, OutBack determines the Product is defective and that the defect is covered under the terms of this Warranty, OutBack will then and only then ship a repaired or replacement Product to the purchaser freight prepaid, non-expedited, using a carrier of OutBack's choice within the continental United States, where applicable.

Shipments to other locations will be made freight collect. The warranty period of any repaired or replacement Product is twelve (12) months from the date of shipment from OutBack, or the remainder of the initial warranty term, which ever is greater.

THIS LIMITED WARRANTY IS THE EXCLUSIVE WARRANTY APPLICABLE TO OUTBACK PRODUCTS. OUTBACK EXPRESSLY DISCLAIMS ANY OTHER EXPRESS OR IMPLIED WARRANTIES OF ITS PRODUCTS, INCLUDING BUT NOT LIMITED TO ANY IMPLIED WARRANTIES OF MERCHANTABILITY OR FITNESS FOR A PARTICULAR PURPOSE. OUTBACK ALSO EXPRESSLY LIMITS ITS LIABILITY IN THE EVENT OF A PRODUCT DEFECT TO REPAIR OR REPLACEMENT IN ACCORDANCE WITH THE TERMS OF THIS LIMITED WARRANTY AND EXCLUDES ALL LIABILITY FOR INCIDENTAL OR CONSEQUENTIAL DAMAGES, INCLUDING WITHOUT LIMITATION ANY LIABILITY FOR PRODUCTS NOT BEING AVAILABLE FOR USE OR LOST REVENUES OR PROFITS, EVEN IF IT IS MADE AWARE OF SUCH POTENTIAL DAMAGES. SOME STATES (OR JURISDICTIONS) MAY NOT ALLOW THE EXCLUSION OR LIMITATION OF WARRANTIES OR DAMAGES, SO THE ABOVE EXCLUSIONS OR LIMITATIONS MAY NOT APPLY TO YOU.



Two Year Limited MX60 Warranty Registration

Complete this form to request a Limited Warranty,
and return it to:

Outback Power Systems Inc.
19009 62nd Ave. NE
Arlington, WA 98223

NOTE: A Limited Warranty Certificate will only be issued if this Registration Card is received by OutBack within 90 days of the date of the first retail sale of the eligible Product. Please submit a copy (not the original) of the Product purchase invoice, which confirms the date and location of purchase, the price paid, and the Product Model and Serial Number.

Two Year Limited MX60 Warranty Registration

System Owner

Name: _____ Country: _____
Address: _____ Telephone Number: _____
City, State, Zip Code: _____ E-mail: _____

Product

Product Model Number: _____ Sold by: _____
Product Serial Number: _____ Purchase Date: _____
Optional Extended Warranty* Coverage? (circle one): Yes No

Please circle the three most important factors affecting your purchase decision:

- Price
- Product Reputation
- Product Features
- Reputation of OutBack Power Systems
- Value

System

System Install/Commission Date: _____ MX60 Charging Source(i.e. Solar): _____
System Array Nominal Voltage: _____ DC Input Wiring Size and Length: _____
Type of Batteries: _____ Number of MX60 Products in System: _____
System Array Size: _____ Type of PV Modules: _____
System Battery Bank Size (Amp Hours): _____

Installer

Name: _____ Address: _____
City, State, Zip: _____ E-mail: _____
Contractor Number: _____

*Extended Warranty

OutBack Power Systems offers an optional three (3) year extension to the standard two (2) year Limited Warranty in North America for the MX60 product. To request a 3-year Limited Warranty extension for a total effective warranty coverage period of five (5) years; include a check or money order in the amount of \$100USD payable to OutBack Power Systems, Inc. along with your Warranty Registration.



Corporate Headquarters
19009 62nd Avenue NE
Arlington, WA 98223 USA
Phone: (+1) 360.435.6030

European Sales Office
C/ Castelló, 17
08830 - Sant Boi de Llobregat
BARCELONA, España
Phone: +34.93.654.9568

www.outbackpower.com

900-0028-01-00 REV D